

This present document and its contents are confidential, and are the exclusive intellectual and / or industrial property of DELVALLE. In addition to any technology, design, invention, work, process, know-how, calculation, method, solution, idea, improvement, drawing, diagram, modification, contribution and, in short, any associated information or documentation involving industrial or intellectual property developed or supplied by DELVALLE on the occasion of the quote, order execution or incorporated into the design or operation of the supply. The recipient may not use such property in his favour or in that of a third party for purposes other than the fulfilment of the order and the operation and maintenance of the supply, without the prior written consent of DELVALLE. It is strictly forbidden to totally or partially reproduce this document and to misuse it and / or to show it to third parties. The infringing parties shall be required to pay the corresponding compensation for damages and any other legal or criminal responsibility. The infringement may give rise to.

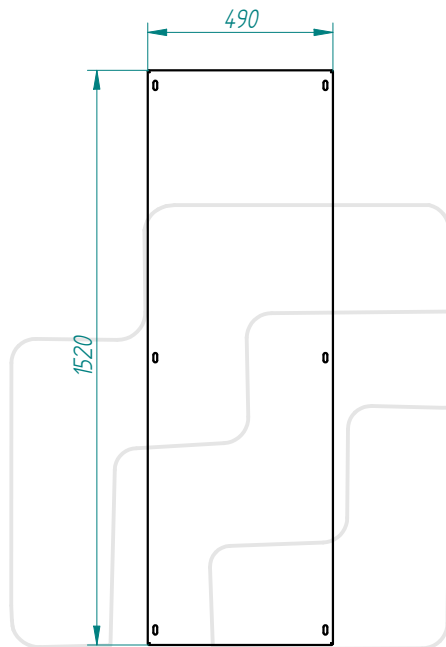

Mechanical area/  
Zone d'usage/  
Zona mecanizado

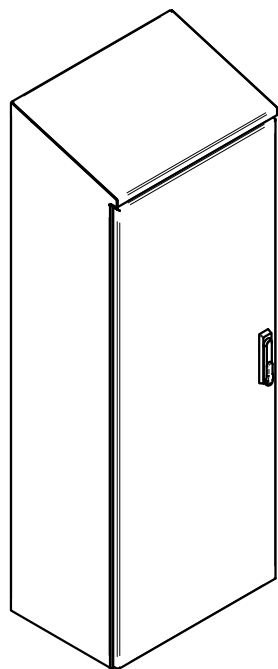
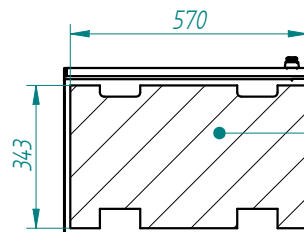

Mechanical area/  
Zone d'usage/  
Zona mecanizado

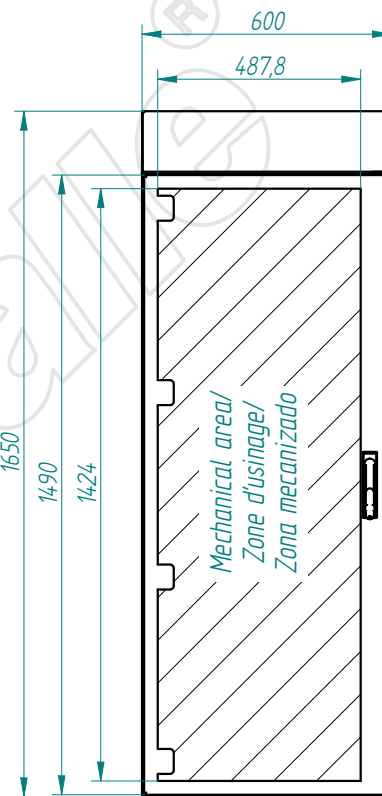

Mechanical area/  
Zone d'usage/  
Zona mecanizado

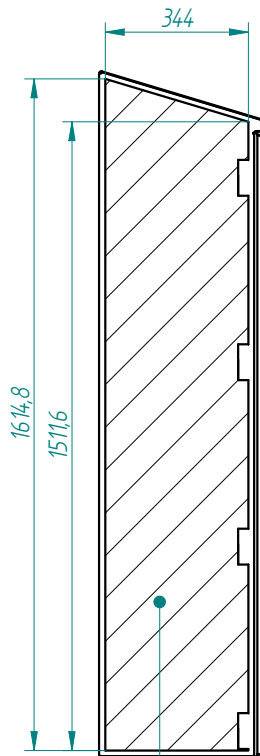

Mechanical area/  
Zone d'usage/  
Zona mecanizado

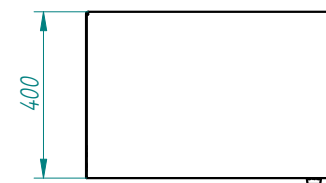

TOLERANCIA GENERAL DE MECANIZACION segun DIN 7168					Referencia:		FECHA: 28/05/2015	FIRMA: D.Martinez	 N° PLANO:
	Creación del documento	28/05/2015	D.MTNEZ	A	- plegado: acabado.	DESIGNACIÓN: tribeca higienic-1650x600x400-estandar	APROBADO: 28/05/2015	D.Martinez	
	MODIFICACIONES	FECHA:	FIRMA:	REVISIÓN:					

This present document and its contents are confidential, and are the exclusive intellectual and / or industrial property of DELVALLE. In addition to any technology, design, invention, work, process, know-how, calculation, manual, method, solution, idea, improvement, drawing, diagram, modification, contribution and, in short, any associated information or documentation involving industrial or intellectual property developed or supplied by DELVALLE on the occasion of the quote, order execution or incorporated into the design or operation of the supply. The recipient may not use such property in his favour or in that of a third party for purposes other than the fulfilment of the order and the operation and maintenance of the supply, without the prior written consent of DELVALLE. It is strictly forbidden to totally or partially reproduce this document and to misuse it and / or to show it to third parties. The infringing parties shall be required to pay the corresponding compensation for damages, and any other legal or criminal responsibility is the infringement may give rise to.

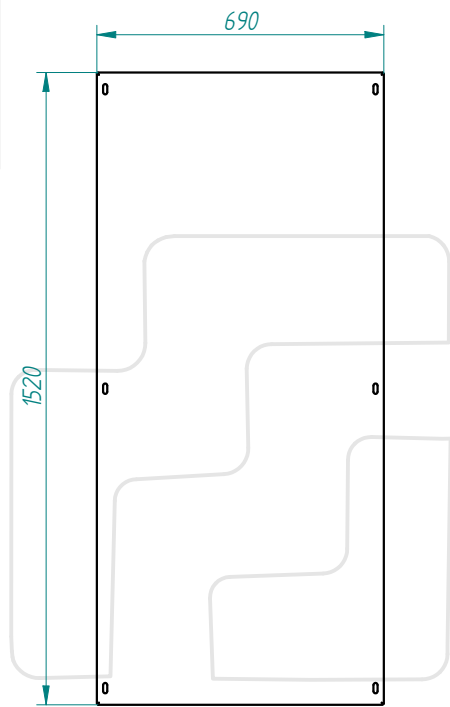
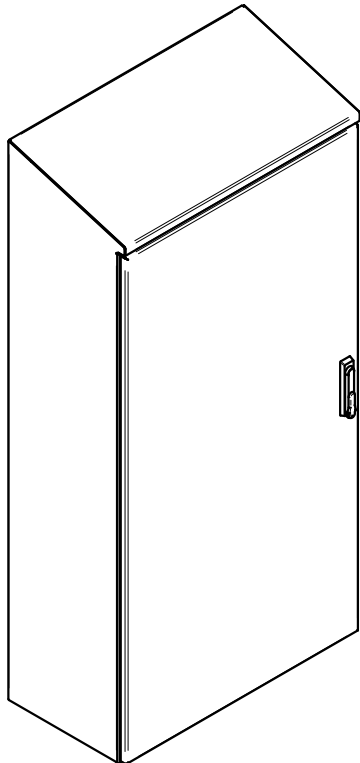

Mechanical area/  
Zone d'usinage/  
Zona mecanizado

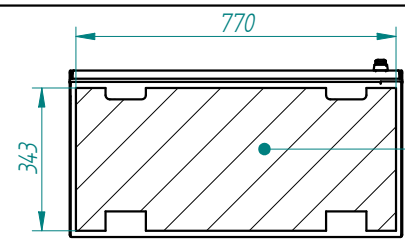
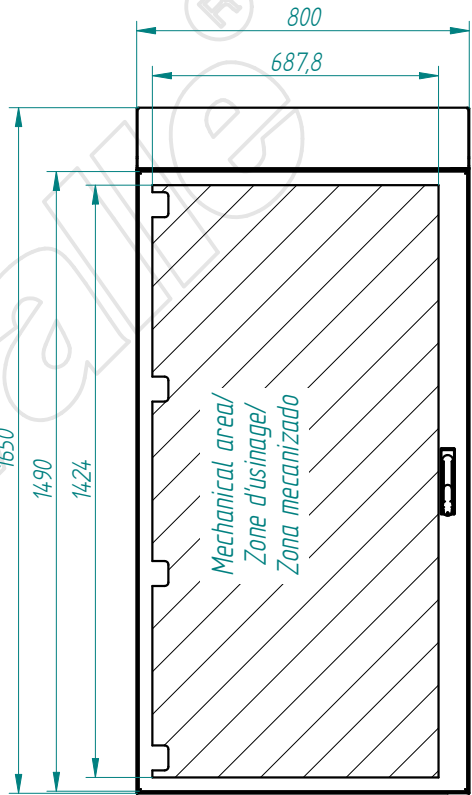
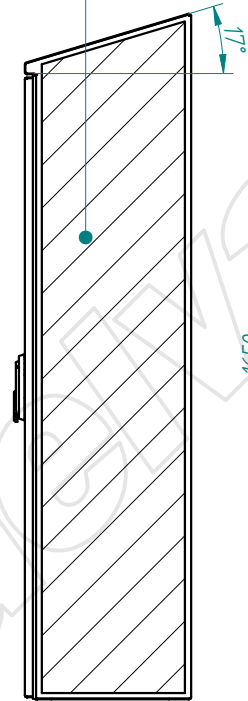

Mechanical area/  
Zone d'usinage/  
Zona mecanizado

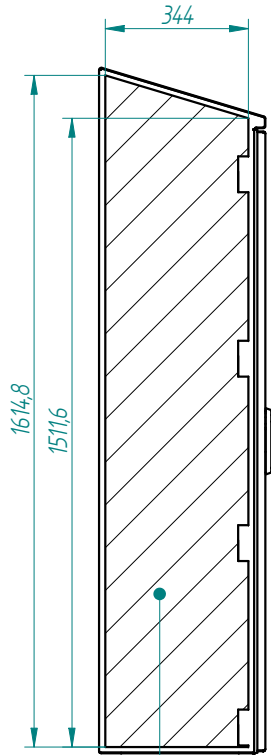

Mechanical area/  
Zone d'usinage/  
Zona mecanizado

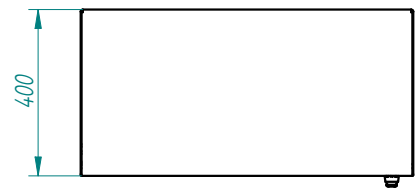

TOLERANCIA GENERAL DE MECANIZACION según DIN 7168					Referencia:		FECHA: 28/05/2015	FIRMA: D.Martínez	 N° PLANO:
						DIBUJADO: 28/05/2015		D.Martínez	
							APROBADO: 28/05/2015		
	Creación del documento	28/05/2015	D.MTNEZ	A	-	DESIGNACIÓN:			
	MODIFICACIONES	FECHA:	FIRMA:	REVISIÓN:	plegado: acabado:	tribeca hygienic-1650x800x400-estandar			

This present document and its contents are confidential, and are the exclusive intellectual and / or industrial property of DELVALLE. In addition to any technology, design, invention, work, process, know-how, calculation, manual, method, solution, idea, improvement, drawing, diagram, modification, contribution and, in short, any associated information or documentation involving industrial or intellectual property developed or supplied by DELVALLE on the occasion of the quote, order execution or incorporated into the design or operation of the supply. The recipient may not use such property in his favour or in that of a third party for purposes other than the fulfilment of the order and the operation and maintenance of the supply, without the prior written consent of DELVALLE. It is strictly forbidden to totally or partially reproduce this document and to misuse it and / or to show it to third parties. The infringing parties shall be required to pay the corresponding compensation for damages, and any other legal or criminal responsibility is the infringement may give rise to.

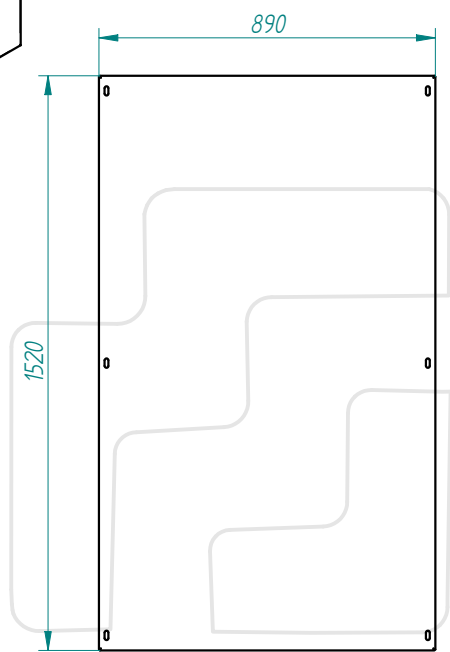
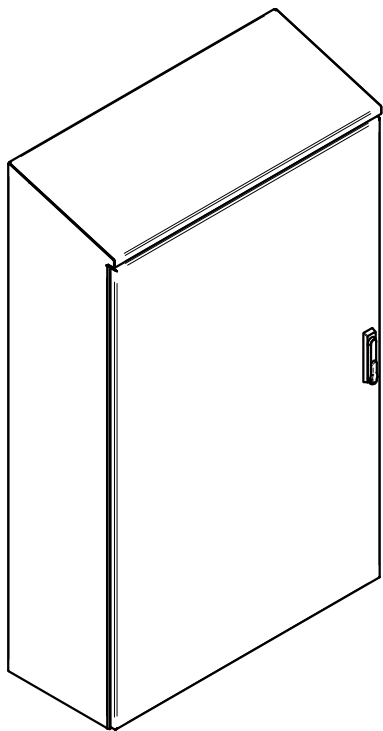

Mechanical area/  
Zone d'usage/  
Zona mecanizado

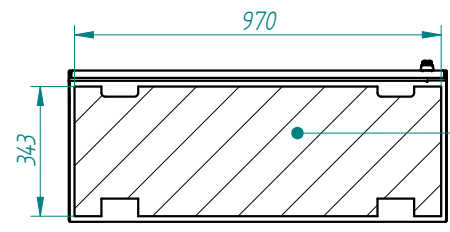
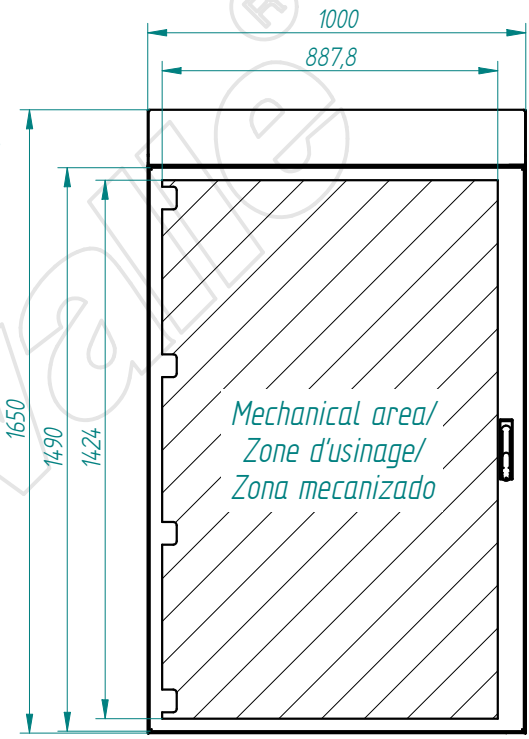
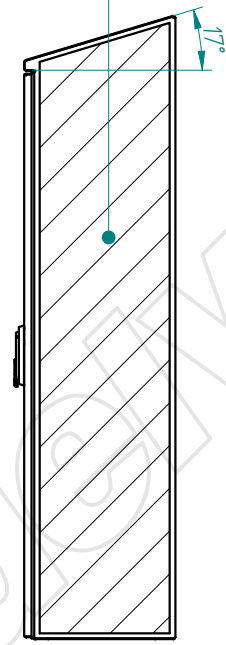

Mechanical area/  
Zone d'usage/  
Zona mecanizado

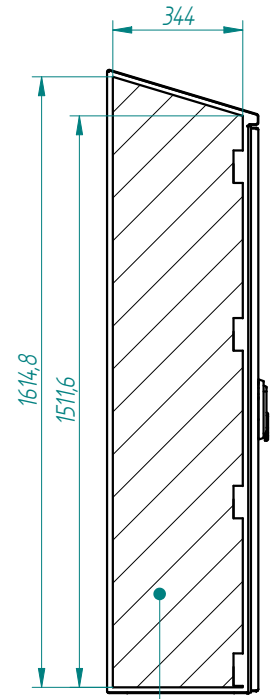

Mechanical area/  
Zone d'usage/  
Zona mecanizado



TOLERANCIA GENERAL DE MECANIZACION segun DIN 7168					Referencia:		FECHA:	FIRMA:	
						DIBUJADO:	28/05/2015	D.Martinez	
							APROBADO:	28/05/2015	D.Martinez
	Creación del documento	28/05/2015	D.MTNEZ	A	-	DESIGNACIÓN:	tribeca hygienic-1650x1000x400-estandar		Nº PLANO:
	MODIFICACIONES	FECHA:	FIRMA:	REVISIÓN:	plegado: acabado:				

This present document and its contents are confidential, and are the exclusive intellectual and / or industrial property of DEVALLE... in addition to any technology, design, invention, work, process, know-how, calculation, manual, method, solution, idea, improvement, drawing, diagram, modification, contribution and, in short, any associated information or documentation involving industrial or intellectual property developed or supplied by DEVALLE on the occasion of the quote, order execution or incorporated into the design or operation of the supply. The recipient may not use such property in his favour or in that of a third party for purposes other than the fulfilment of the order and the operation and maintenance of the supply, without the prior written consent of DEVALLE. It is strictly forbidden to totally or partially reproduce this document and to misuse it and / or to show it to third parties. The infringing parties shall be required to pay the corresponding compensation for damages, and any other legal or criminal responsibility is the infringement may give rise to.

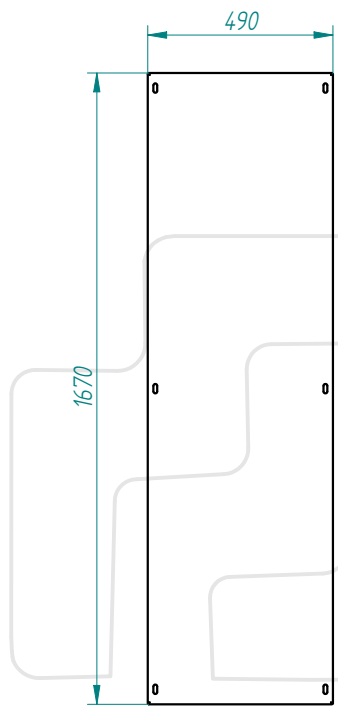
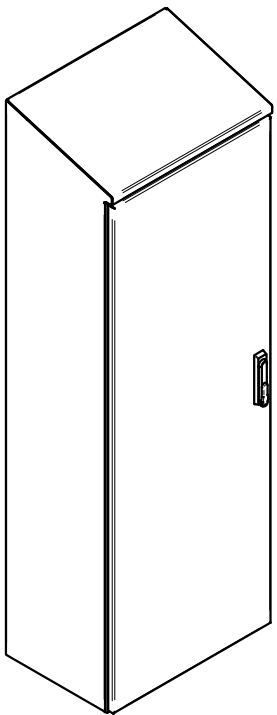

Mechanical area/  
Zone d'usinage/  
Zona mecanizado

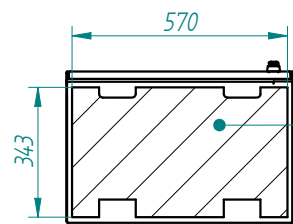
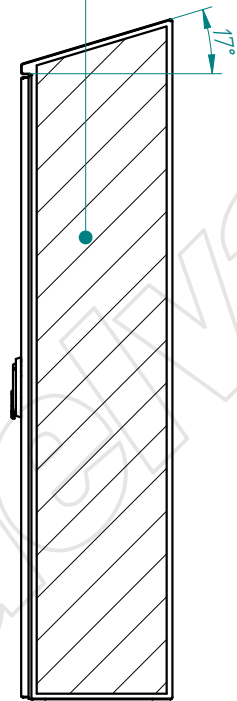

Mechanical area/  
Zone d'usinage/  
Zona mecanizado

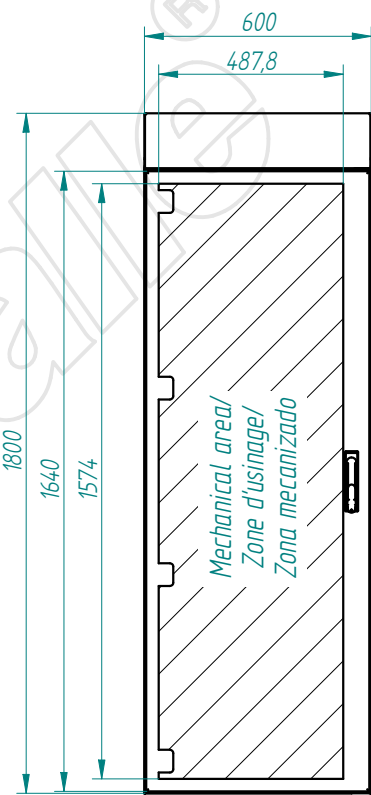

Mechanical area/  
Zone d'usinage/  
Zona mecanizado

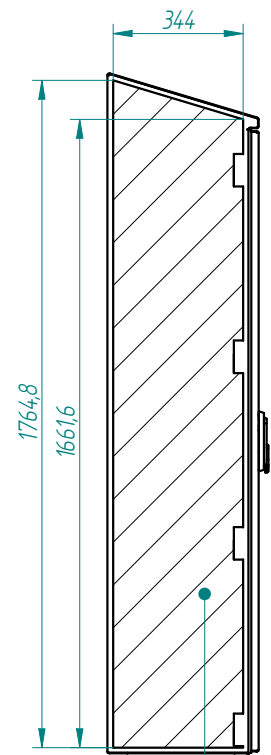

Mechanical area/  
Zone d'usinage/  
Zona mecanizado



TOLERANCIA GENERAL DE MECANIZACION segun DIN 7168					Referencia:		FECHA: 28/05/2015	FIRMA: D.Martinez	
						DIBUJADO: 28/05/2015		D.Martinez	
							APROBADO: 28/05/2015		D.Martinez
	Creación del documento	28/05/2015	D.MTNEZ	A	- plegado: acabado:	DESIGNACIÓN: tribeca higienic-1800x600x400-estandar			
	MODIFICACIONES	FECHA:	FIRMA:	REVISIÓN:					

This present document and its contents are confidential, and are the exclusive intellectual and / or industrial property of DELVALLE. In addition to any technology, design, invention, work, process, know-how, calculation, manual, method, solution, idea, improvement, drawing, diagram, modification, contribution and, in short, any associated information or documentation involving industrial or intellectual property developed or supplied by DELVALLE on the occasion of the quote, order execution or incorporated into the design or operation of the supply. The recipient may not use such property in his favour or in that of a third party for purposes other than the fulfilment of the order and the operation and maintenance of the supply, without the prior written consent of DELVALLE. It is strictly forbidden to totally or partially reproduce this document and to misuse it and / or to show it to third parties. The infringing parties shall be required to pay the corresponding compensation for damages, and any other legal or criminal responsibility is the infringement may give rise to.

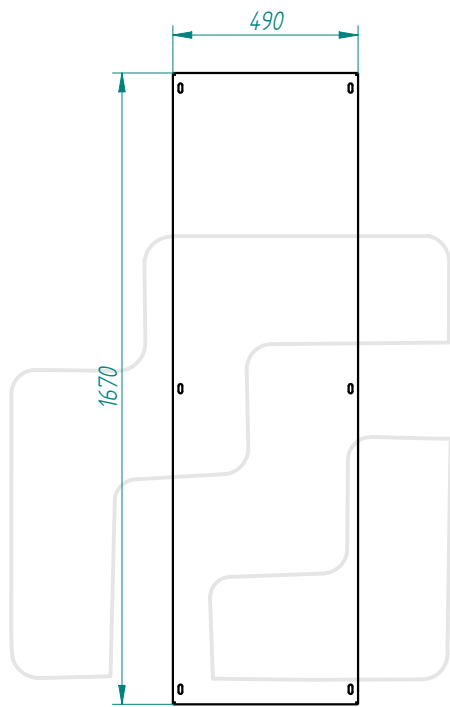
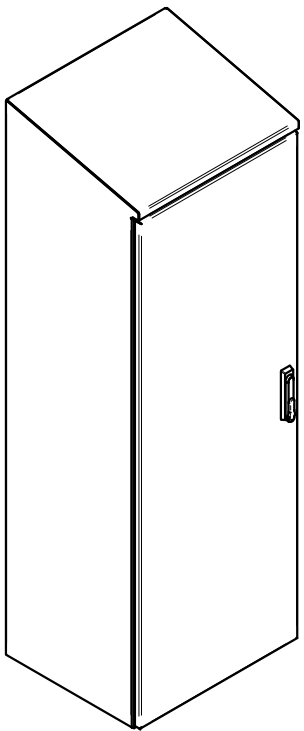

Mechanical area/  
Zone d'usinage/  
Zona mecanizado

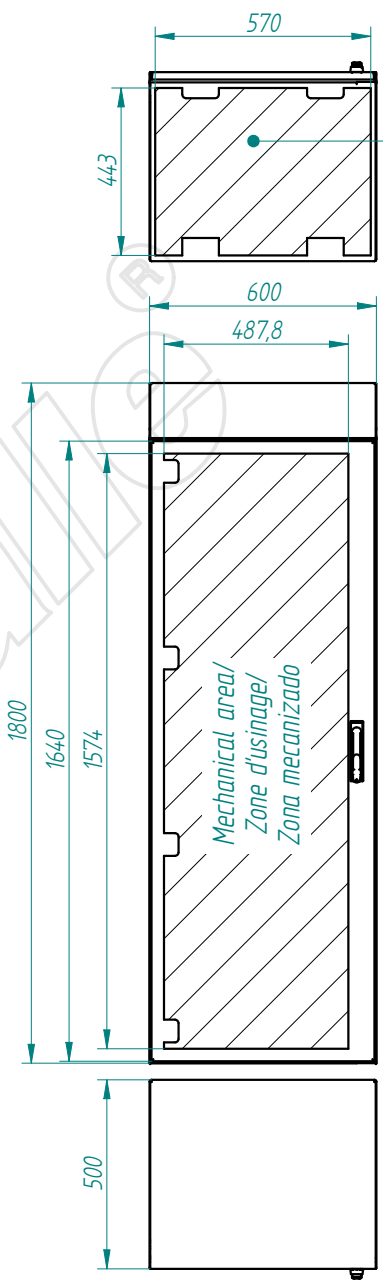
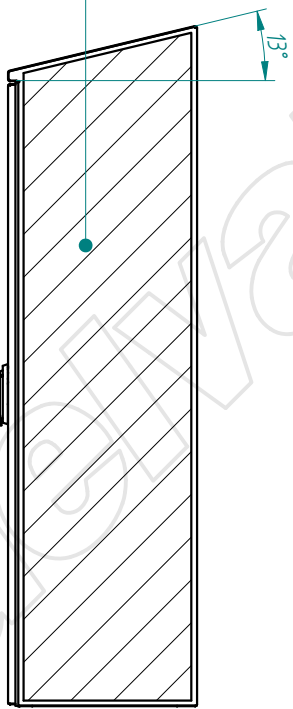

Mechanical area/  
Zone d'usinage/  
Zona mecanizado

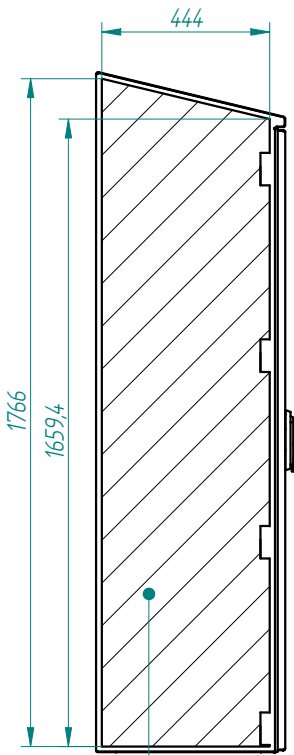

Mechanical area/  
Zone d'usinage/  
Zona mecanizado



TOLERANCIA GENERAL DE MECANIZACION segun DIN 7168					Referencia:		FECHA: 28/05/2015	FIRMA: D.Martinez
							28/05/2015	D.Martinez
	Creación del documento	28/05/2015	D.MTNEZ	A	-	DESIGNACIÓN:	Nº PLANO:	
	MODIFICACIONES	FECHA:	FIRMA:	REVISIÓN:	plegado: acabado:	tribeca hygienic-1800x600x500-estandar		



This present document and its contents are confidential, and are the exclusive intellectual and / or industrial property of DELVALLE . In addition to any technology, design, invention, work, process, know-how, calculation, manual, method, solution, idea, improvement, drawing, diagram, modification, contribution and, in short, any associated information or documentation involving industrial or intellectual property developed or supplied by DELVALLE on the occasion of the quote, order execution or incorporated into the design or operation of the supply. The recipient may not use such property in his favour or in that of a third party for purposes other than the fulfilment of the order and the operation and maintenance of the supply, without the prior written consent of DELVALLE. It is strictly forbidden to totally or partially reproduce this document and to misuse it and / or to show it to third parties. The infringing parties shall be required to pay the corresponding compensation for damages and any other legal or criminal responsibilities. The infringement may give rise to.

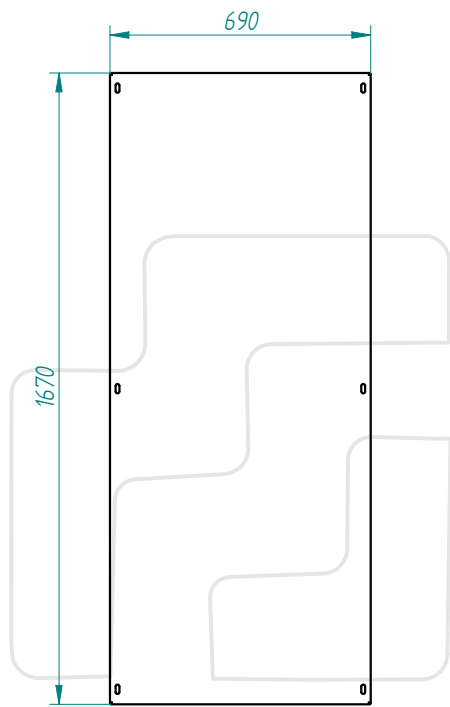
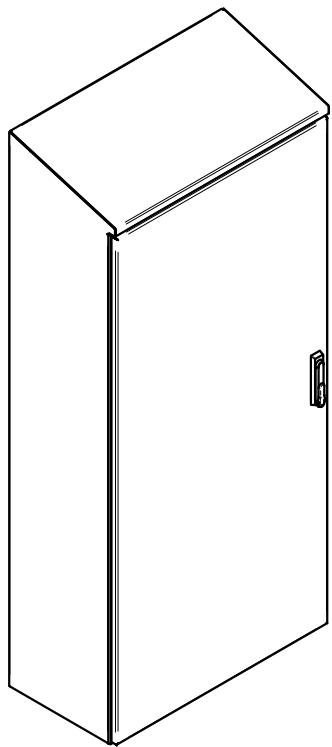

Mechanical area/  
Zone d'usage/  
Zona mecanizado

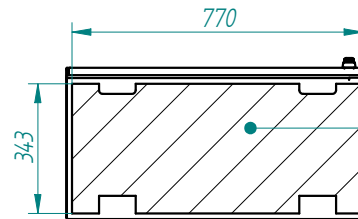
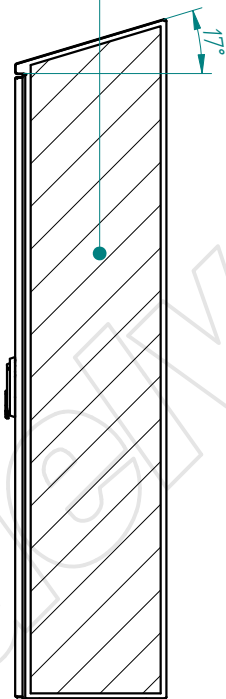

Mechanical area/  
Zone d'usage/  
Zona mecanizado

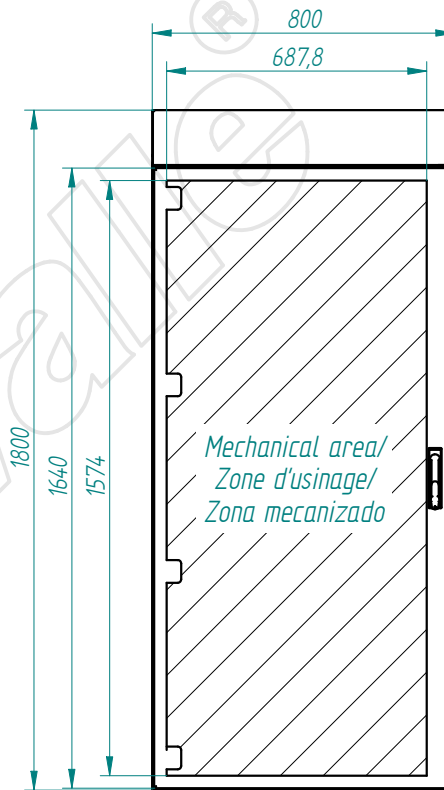

Mechanical area/  
Zone d'usage/  
Zona mecanizado

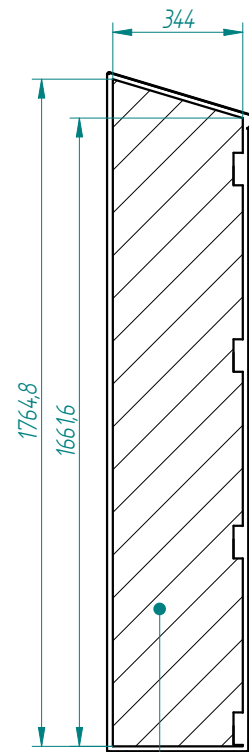

Mechanical area/  
Zone d'usage/  
Zona mecanizado

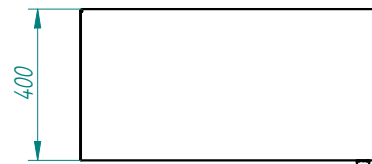

TOLERANCIA GENERAL DE MECANIZACION segun DIN 7168					Referencia:		FECHA: 28/05/2015	FIRMA: D.Martinez	
						DIBUJADO: 28/05/2015	D.Martinez		
							APROBADO: 28/05/2015	D.Martinez	
	Creación del documento	28/05/2015	D.MTNEZ	A	-	DESIGNACIÓN:			Nº PLANO:
	MODIFICACIONES	FECHA:	FIRMA:	REVISIÓN:	plegado: acabado:	tribeca hygienic-1800x800x400-estandar			

This present document and its contents are confidential, and are the exclusive intellectual and / or industrial property of DELVALLE. In addition to any technology, design, invention, work, process, know-how, calculation, manual, method, solution, idea, improvement, drawing, diagram, modification, contribution and, in short, any associated information or documentation involving industrial or intellectual property developed or supplied by DELVALLE on the occasion of the quote, order execution or incorporated into the design or operation of the supply. The recipient may not use such property in his favour or in that of a third party for purposes other than the fulfilment of the order and the operation and maintenance of the supply, without the prior written consent of DELVALLE. It is strictly forbidden to totally or partially reproduce this document and to misuse it and / or to show it to third parties. The infringing parties shall be required to pay the corresponding compensation for damages, and any other legal or criminal responsibility is the infringement may give rise to.

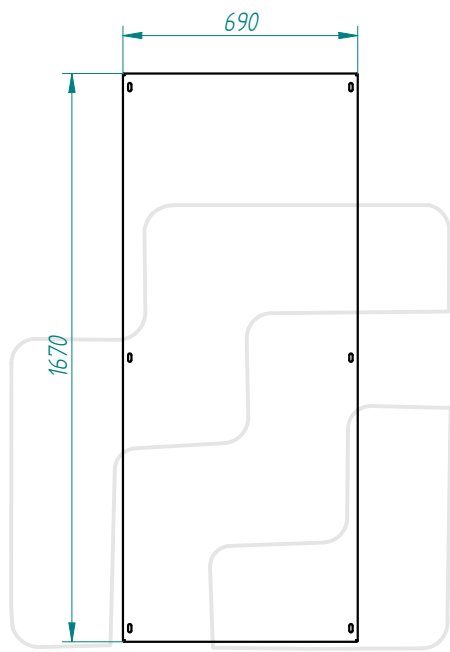
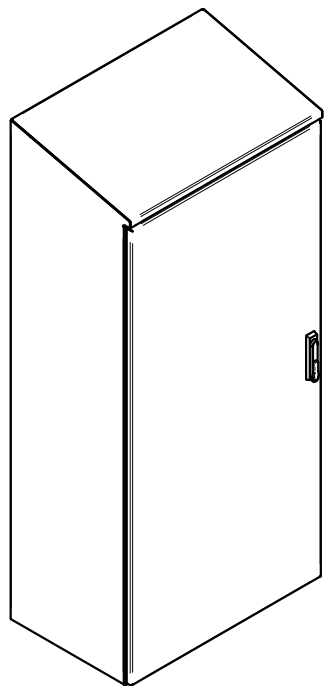

Mechanical area/  
Zone d'usinage/  
Zona mecanizado

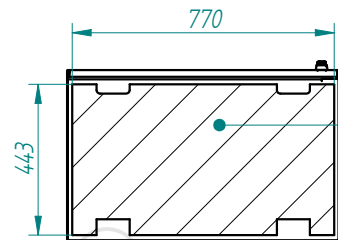
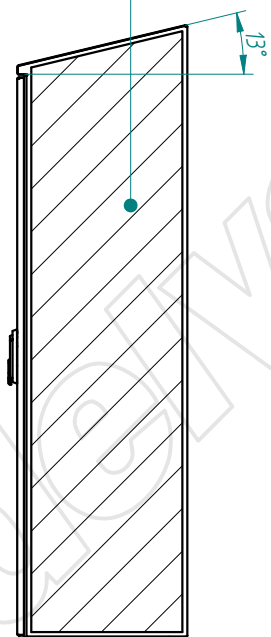

Mechanical area/  
Zone d'usinage/  
Zona mecanizado

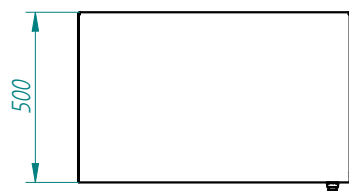
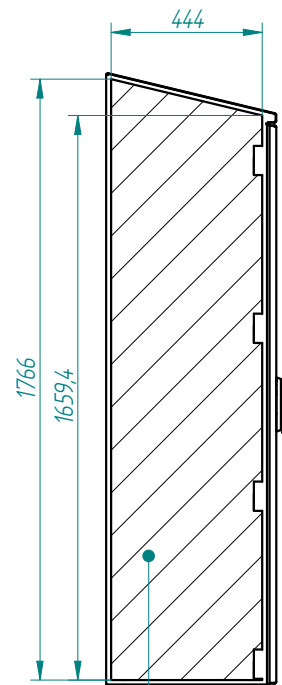
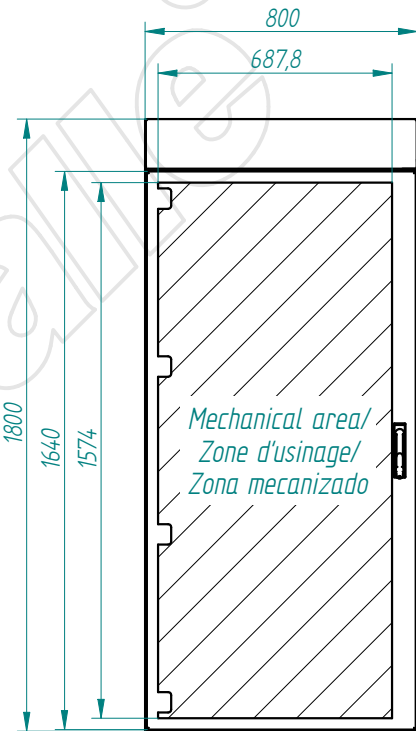

Mechanical area/  
Zone d'usinage/  
Zona mecanizado



TOLERANCIA GENERAL DE MECANIZACION segun DIN 7168	Creación del documento	28/05/2015	D.MTNEZ	A	Referencia: - plegado: acabado:	DIBUJADO:	28/05/2015	FIRMA:	D.Martinez	DESIGNACIÓN: <b>tribeca higienic-1800x800x500-estandar</b>	Nº PLANO:
	MODIFICACIONES	FECHA:	FIRMA:	REVISIÓN:		APROBADO:	28/05/2015	D.Martinez			



This present document and its contents are confidential, and are the exclusive intellectual and / or industrial property of DEVALLE. In addition to any technology, design, invention, work, process, know-how, calculation, manual, method, solution, idea, improvement, drawing, diagram, modification, contribution and, in short, any associated information or documentation involving industrial or intellectual property developed or supplied by DEVALLE on the occasion of the quote, order execution or incorporated into the design or operation of the supply. The recipient may not use such property in his favour or in that of a third party for purposes other than the fulfilment of the order and the operation and maintenance of the supply, without the prior written consent of DEVALLE. It is strictly forbidden to totally or partially reproduce this document and to misuse it and / or to show it to third parties. The infringing parties shall be required to pay the corresponding compensation for damages, and any other legal or criminal responsibilities that the infringement may give rise to.

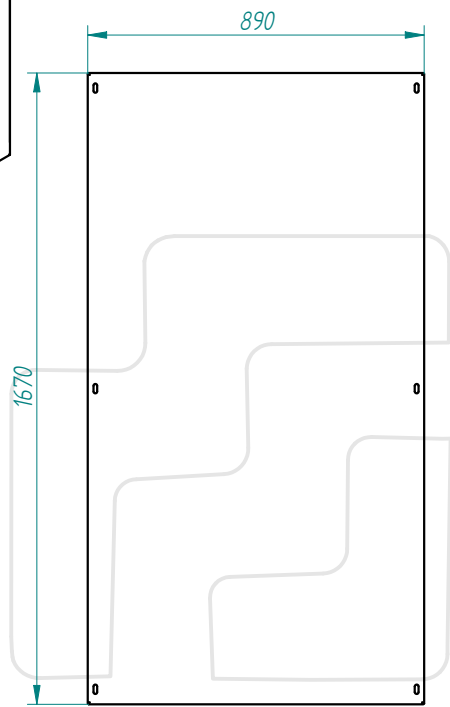
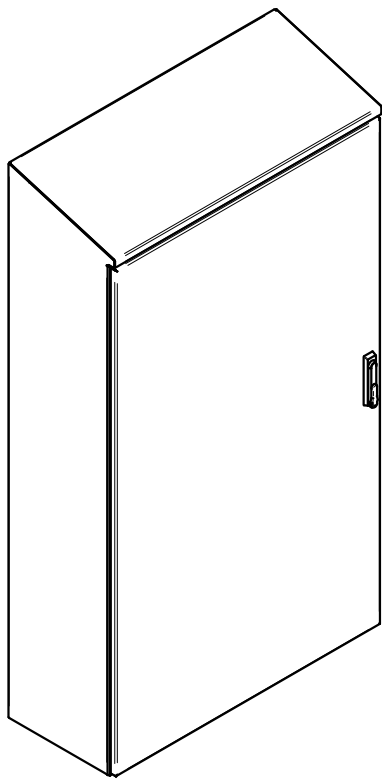

Mechanical area/  
Zone d'usage/  
Zona mecanizado

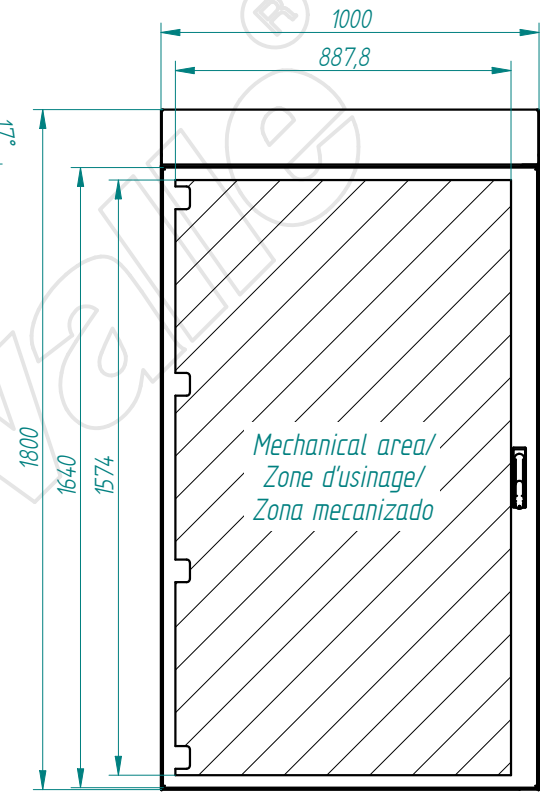
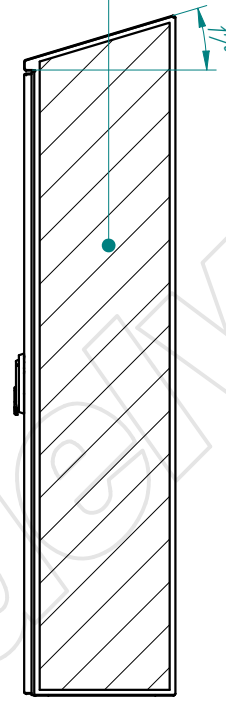

Mechanical area/  
Zone d'usage/  
Zona mecanizado

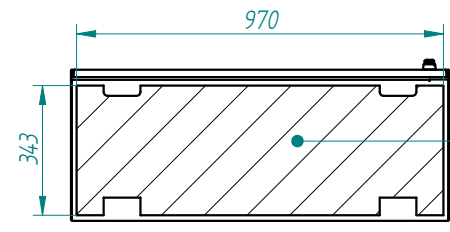

Mechanical area/  
Zone d'usage/  
Zona mecanizado

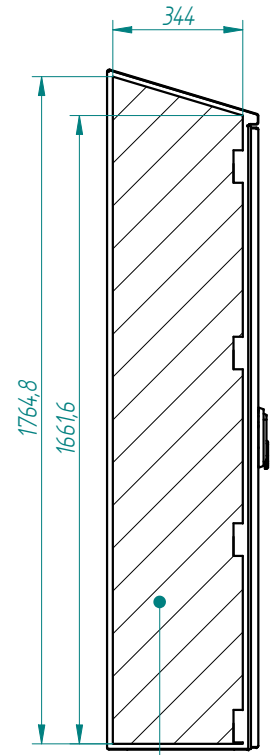

Mechanical area/  
Zone d'usage/  
Zona mecanizado



TOLERANCIA GENERAL DE MECANIZACION segun DIN 7168					Referencia:		FECHA:	FIRMA:	 Nº PLANO:
						DIBUJADO:	28/05/2015	D.Martinez	
						APROBADO:	28/05/2015	D.Martinez	
	Creación del documento	28/05/2015	D.MTNEZ	A	-	DESIGNACIÓN:			
	MODIFICACIONES	FECHA:	FIRMA:	REVISIÓN:	plegado: acabado:	tribeca higienic-1800x1000x400-estandar			



This present document and its contents are confidential, and are the exclusive intellectual and / or industrial property of DEVALLE. In addition to any technology, design, invention, work, process, know-how, calculation, manual, method, solution, idea, improvement, drawing, diagram, modification, contribution and, in short, any associated information or documentation involving industrial or intellectual property developed or supplied by DEVALLE on the occasion of the quote, order execution or incorporated into the design or operation of the supply. The recipient may not use such property in his favour or in that of a third party for purposes other than the fulfilment of the order and the operation and maintenance of the supply, without the prior written consent of DEVALLE. It is strictly forbidden to totally or partially reproduce this document and to misuse it and / or to show it to third parties. The infringing parties shall be required to pay the corresponding compensation for damages, and any other legal or criminal responsibility is the infringement may give rise to.

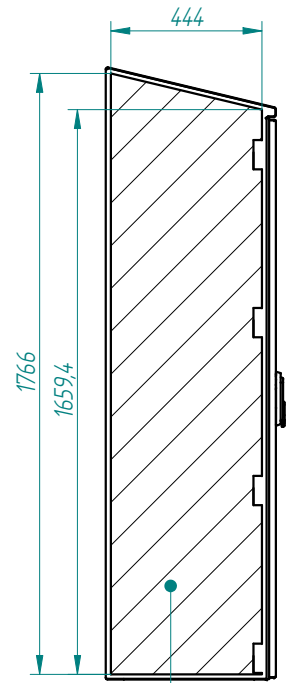
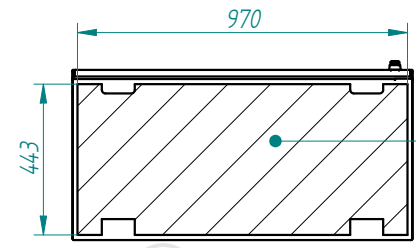
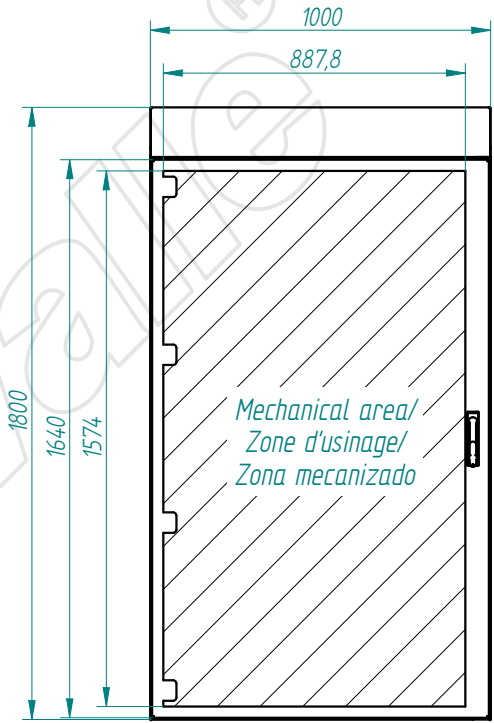
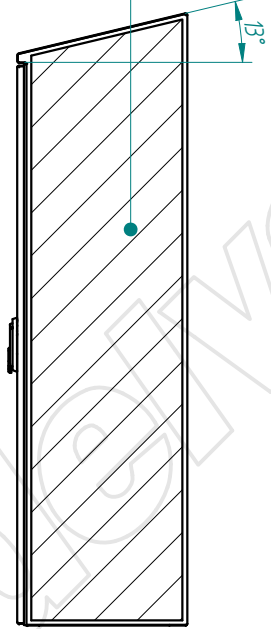
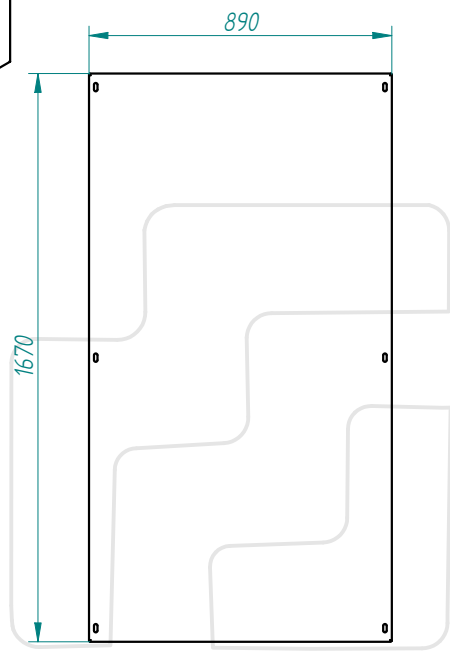
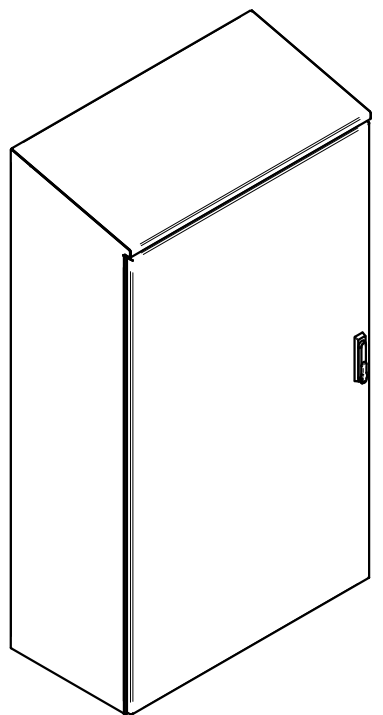

Mechanical area/  
Zone d'usage/  
Zona mecanizado

Mechanical area/  
Zone d'usage/  
Zona mecanizado

Mechanical area/  
Zone d'usage/  
Zona mecanizado

Mechanical area/  
Zone d'usage/  
Zona mecanizado



TOLERANCIA GENERAL DE MECANIZACION segun DIN 7168					Referencia:		FECHA: 28/05/2015	FIRMA: D.Martinez
						DIBUJADO: 28/05/2015		D.Martinez
						APROBADO: 28/05/2015		D.Martinez
	Creación del documento	28/05/2015	D.MTNEZ	A	- plegado: acabado:	DESIGNACIÓN: tribeca higienic-1800x1000x500-estandar	Nº PLANO:	
	MODIFICACIONES	FECHA:	FIRMA:	REVISIÓN:				



This present document and its contents are confidential, and are the exclusive intellectual and / or industrial property of DEVALLE. In addition to any technology, design, invention, work, process, know-how, calculation, manual, method, solution, idea, improvement, drawing, diagram, modification, contribution and, in short, any associated information or documentation involving industrial or intellectual property developed or supplied by DEVALLE on the occasion of the quote, order execution or incorporated into the design or operation of the supply. The recipient may not use such property in his favour or in that of a third party for purposes other than the fulfilment of the order and the operation and maintenance of the supply, without the prior written consent of DEVALLE. It is strictly forbidden to totally or partially reproduce this document and to misuse it and / or to show it to third parties. The infringing parties shall be required to pay the corresponding compensation for damages, and any other legal or criminal responsibility. The infringement may give rise to.

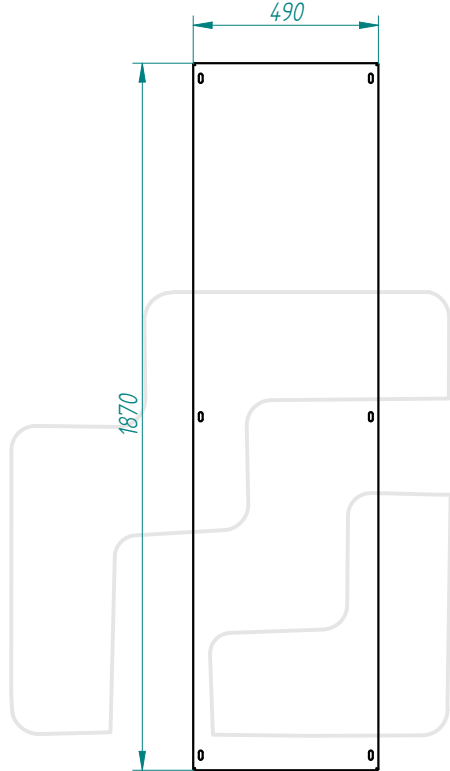
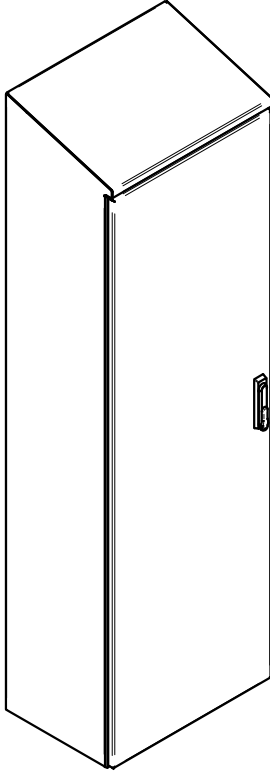

Mechanical area/  
Zone d'usinage/  
Zona mecanizado

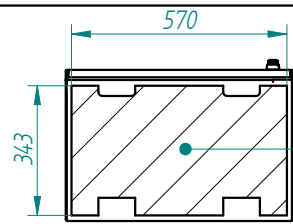
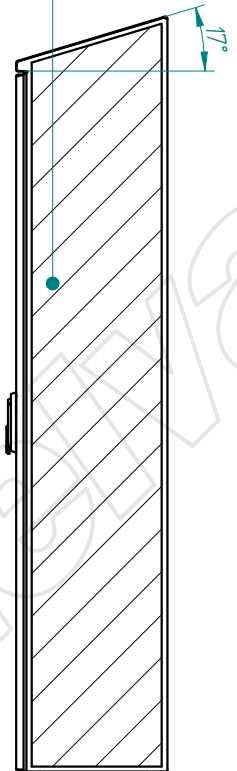

Mechanical area/  
Zone d'usinage/  
Zona mecanizado

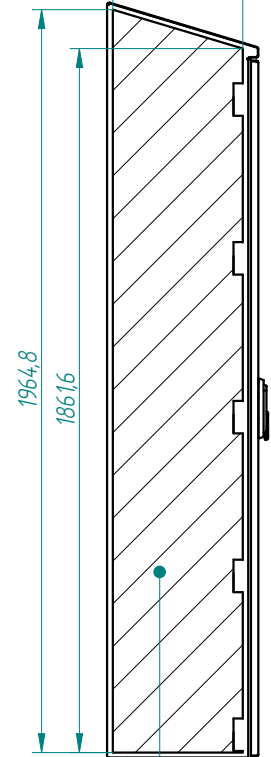
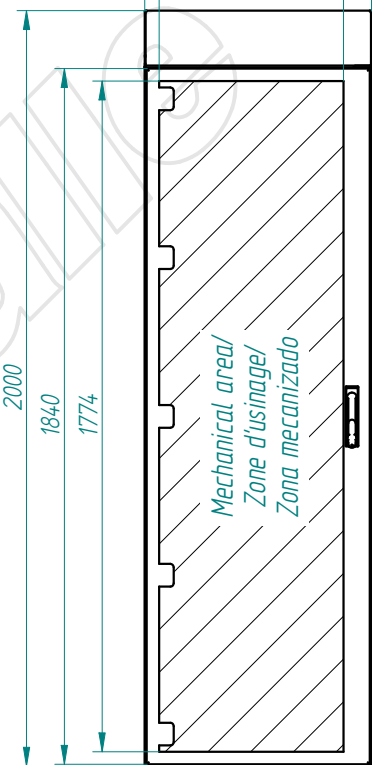

Mechanical area/  
Zone d'usinage/  
Zona mecanizado



TOLERANCIA GENERAL DE MECANIZACION segun DIN 7168					Referencia:		FECHA: 28/05/2015	FIRMA: D.Martinez	
						DIBUJADO: 28/05/2015	D.Martinez		
							APROBADO: 28/05/2015	D.Martinez	
	Creación del documento	28/05/2015	D.MTNEZ	A	-	DESIGNACIÓN:			Nº PLANO:
	MODIFICACIONES	FECHA:	FIRMA:	REVISIÓN:	plegado: acabado:	tribeca hygienic-2000x600x400-estandar			

This present document and its contents are confidential, and are the exclusive intellectual and / or industrial property of DELVALLE. In addition to any technology, design, invention, work, process, know-how, calculation, manual, method, solution, idea, improvement, drawing, diagram, modification, contribution and, in short, any associated information or documentation involving industrial or intellectual property developed or supplied by DELVALLE on the occasion of the quote, order execution or incorporated into the design or operation of the supply. The recipient may not use such property in his favour or in that of a third party for purposes other than the fulfilment of the order and the operation and maintenance of the supply, without the prior written consent of DELVALLE. It is strictly forbidden to totally or partially reproduce this document and to misuse it and / or to show it to third parties. The infringing parties shall be required to pay the corresponding compensation for damages, and any other legal or criminal responsibility is the infringement may give rise to.

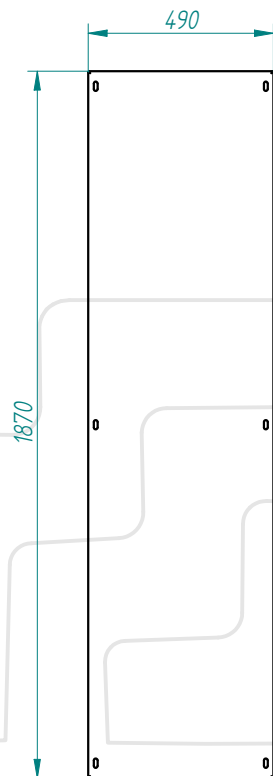
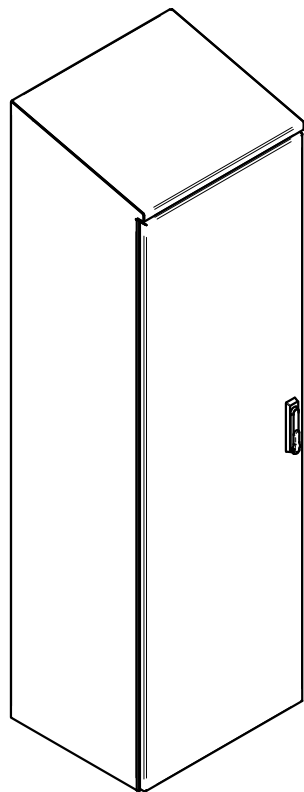

Mechanical area/  
Zone d'usinage/  
Zona mecanizado

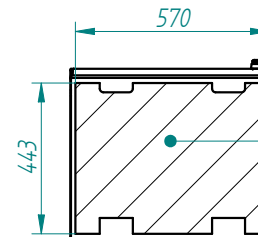
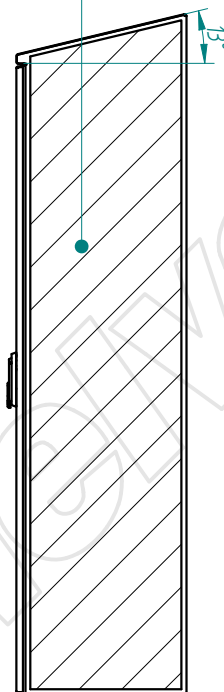

Mechanical area/  
Zone d'usinage/  
Zona mecanizado

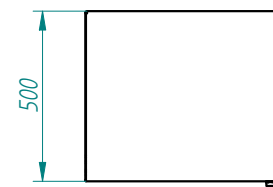
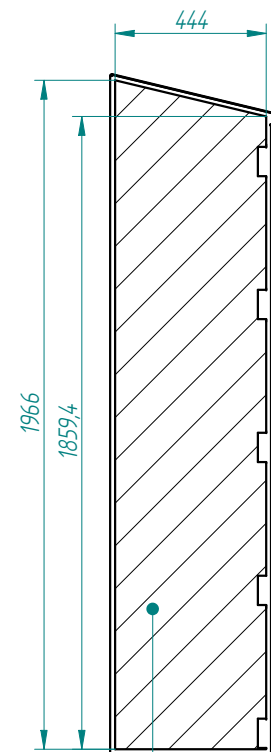
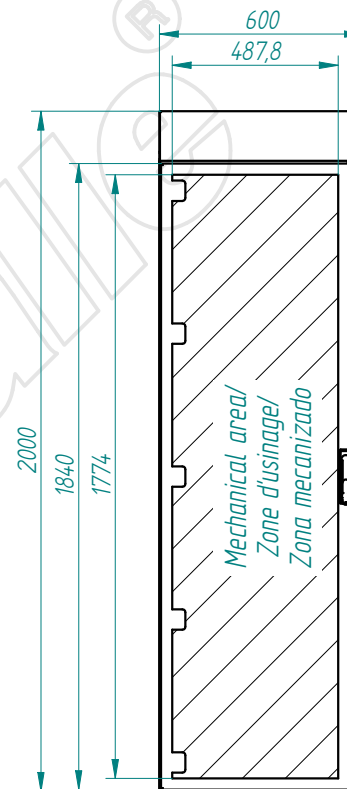

Mechanical area/  
Zone d'usinage/  
Zona mecanizado



TOLERANCIA GENERAL DE MECANIZACION segun DIN 7168					Referencia:		FECHA: 30/07/2015	FIRMA: D.Martinez	
						DIBUJADO: 30/07/2015		D.Martinez	
							APROBADO: 30/07/2015		D.Martinez
	Creación del documento	30/07/2015	D.MTNEZ	A	-	DESIGNACIÓN:			
	MODIFICACIONES	FECHA:	FIRMA:	REVISIÓN:	plegado: acabado:	tribeca hygienic-2000x600x500-estandar			

This present document and its contents are confidential, and are the exclusive intellectual and / or industrial property of DELVALLE. In addition to any technology, design, invention, work, process, know-how, calculation, manual, method, solution, idea, improvement, drawing, diagram, modification, contribution and, in short, any associated information or documentation involving industrial or intellectual property developed or supplied by DELVALLE on the occasion of the quote, order execution or incorporated into the design or operation of the supply. The recipient may not use such property in his favour or in that of a third party for purposes other than the fulfilment of the order and the operation and maintenance of the supply, without the prior written consent of DELVALLE. It is strictly forbidden to totally or partially reproduce this document and to misuse it and / or to show it to third parties. The infringing parties shall be required to pay the corresponding compensation for damages, and any other legal or criminal responsibility. The infringement may give rise to.

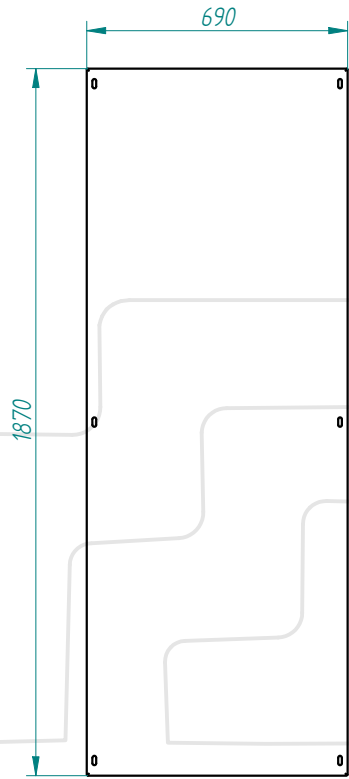
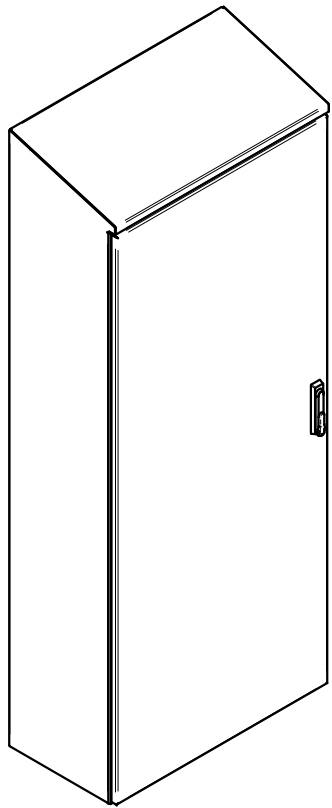

Mechanical area/  
Zone d'usage/  
Zona mecanizado

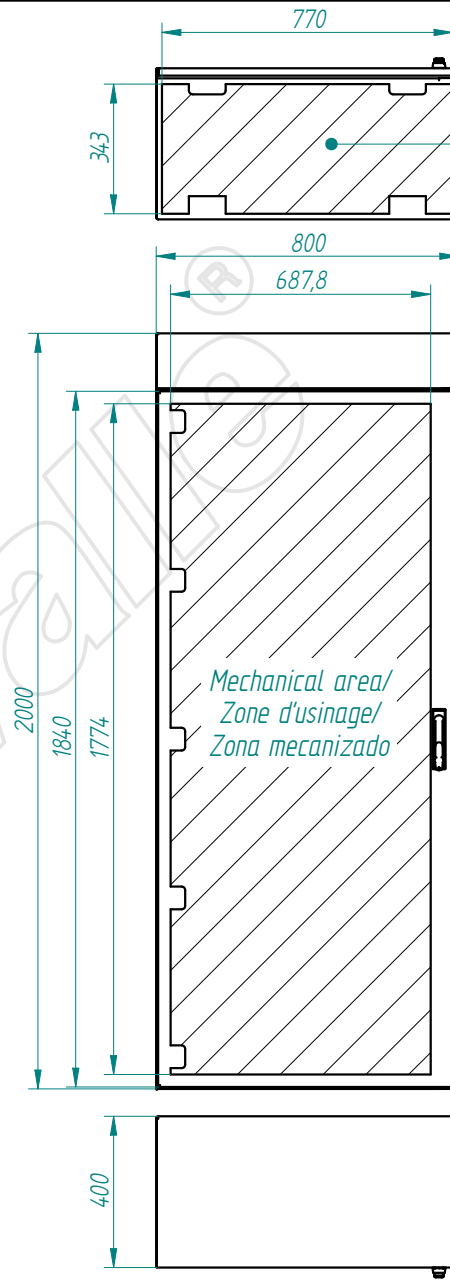
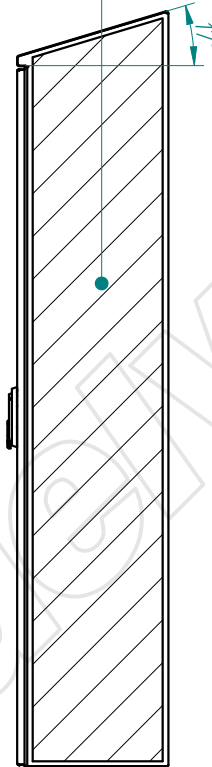

Mechanical area/  
Zone d'usage/  
Zona mecanizado

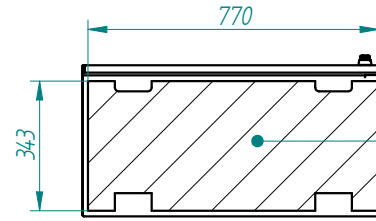

Mechanical area/  
Zone d'usage/  
Zona mecanizado

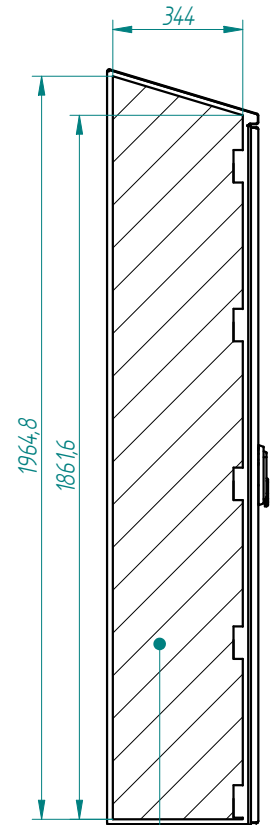

Mechanical area/  
Zone d'usage/  
Zona mecanizado



TOLERANCIA GENERAL DE MECANIZACION segun DIN 7168	Creación del documento	28/05/2015	D.MTNEZ	A	Referencia: - plegado: acabado.	DIBUJADO:	28/05/2015	FIRMA: D.Martinez
	MODIFICACIONES	FECHA:	FIRMA:	REVISIÓN:		APROBADO:	28/05/2015	D.Martinez
						DESIGNACIÓN:	tribeca higienic-2000x800x400-estandar	
								Nº PLANO:



This present document and its contents are confidential, and are the exclusive intellectual and / or industrial property of DEVALLE. In addition to any technology, design, invention, work, process, know-how, calculation, manual, method, solution, idea, improvement, drawing, diagram, modification, contribution and, in short, any associated information or documentation involving industrial or intellectual property developed or supplied by DEVALLE on the occasion of the quote, order execution or incorporated into the design or operation of the supply. The recipient may not use such property in his favour or in that of a third party for purposes other than the fulfilment of the order and the operation and maintenance of the supply, without the prior written consent of DEVALLE. It is strictly forbidden to totally or partially reproduce this document and to misuse it and / or to show it to third parties. The infringing parties shall be required to pay the corresponding compensation for damages, and any other legal or criminal responsibility is the infringement may give rise to.

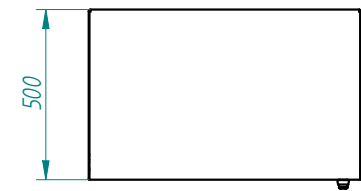
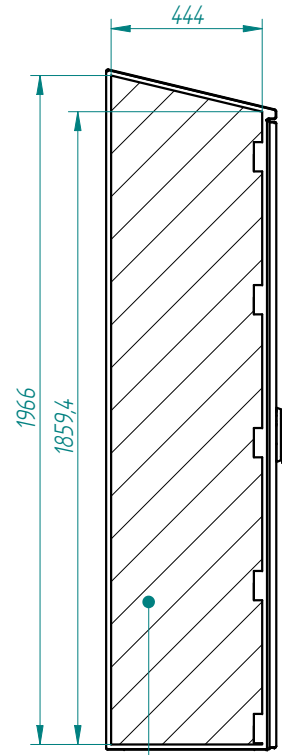
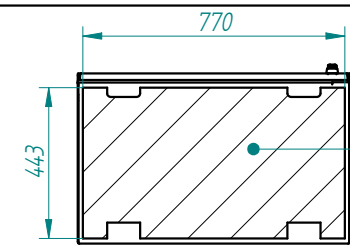
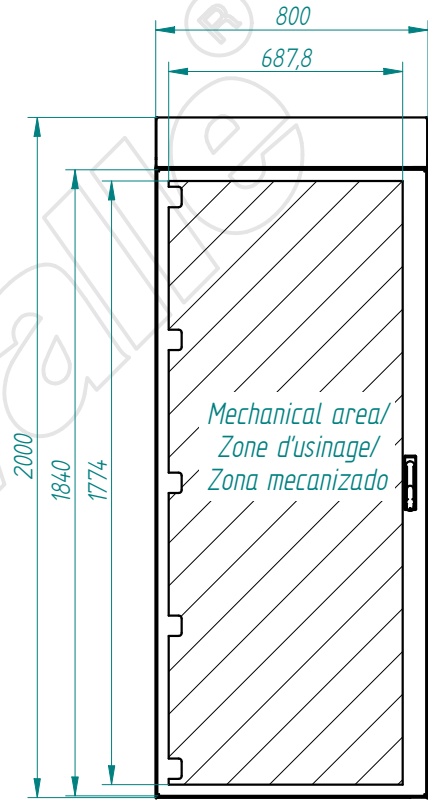
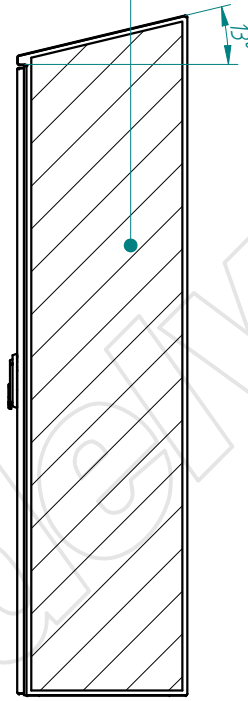
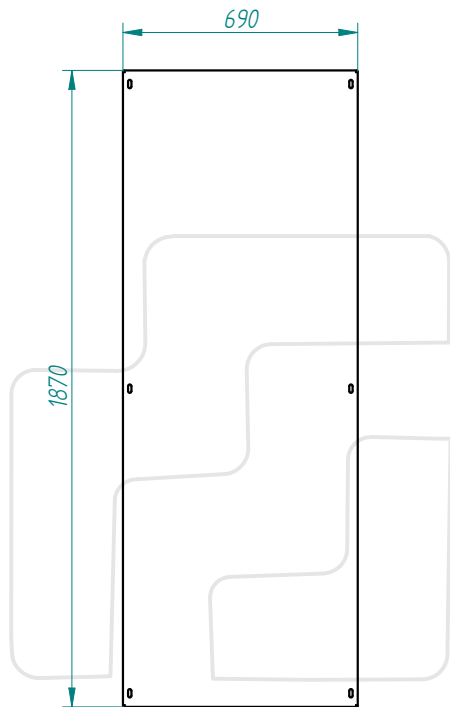
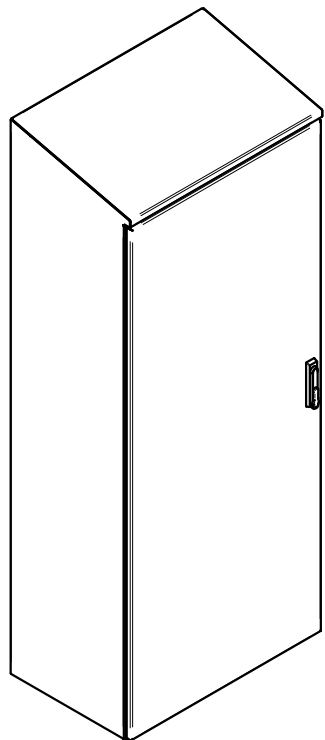

TOLERANCIA GENERAL DE MECANIZACION según DIN 7168					Referencia:		FECHA:	FIRMA:	
						DIBUJADO:	28/05/2015	D.Martínez	
						APROBADO:	28/05/2015	D.Martínez	
	Creación del documento	28/05/2015	D.MTNEZ	A	-	DESIGNACIÓN:	tribeca hygienic-2000x800x500-estandar		Nº PLANO:
	MODIFICACIONES	FECHA:	FIRMA:	REVISIÓN:	plegado: acabado:				

This present document and its contents are confidential, and are the exclusive intellectual and / or industrial property of DEVALLE ., in addition to any technology, design, invention, work, process, know-how, calculation, manual, method, solution, idea, improvement, drawing, diagram, modification, contribution and, in short, any associated information or documentation involving industrial or intellectual property developed or supplied by DEVALLE on the occasion of the quote, order execution or incorporated into the design or operation of the supply. The recipient may not use such property in his favour or in that of a third party for purposes other than the fulfilment of the order and the operation and maintenance of the supply, without the prior written consent of DEVALLE. It is strictly forbidden to totally or partially reproduce this document and to misuse it and / or to show it to third parties. The infringing parties shall be required to pay the corresponding compensation for damages, and any other legal or criminal responsibilities. The infringement may give rise to.

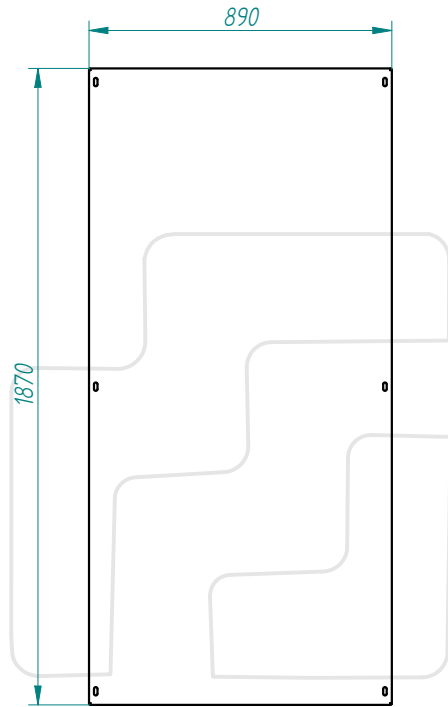
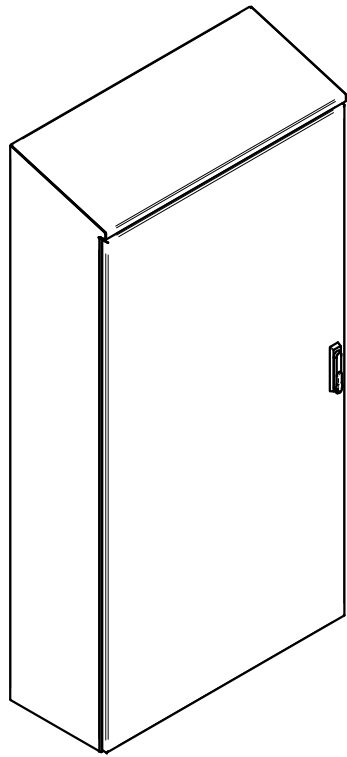

*Mechanical area/  
Zone d'usage/  
Zona mecanizado*

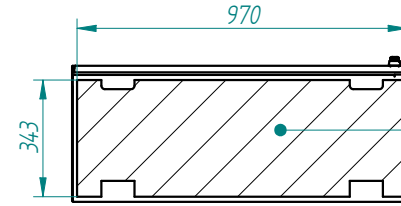
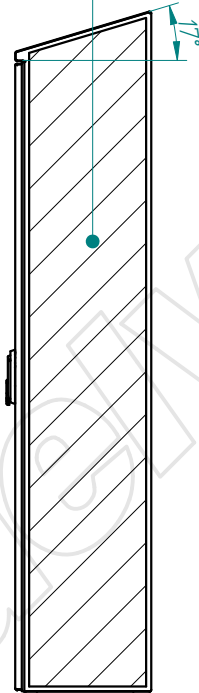

*Mechanical area/  
Zone d'usage/  
Zona mecanizado*

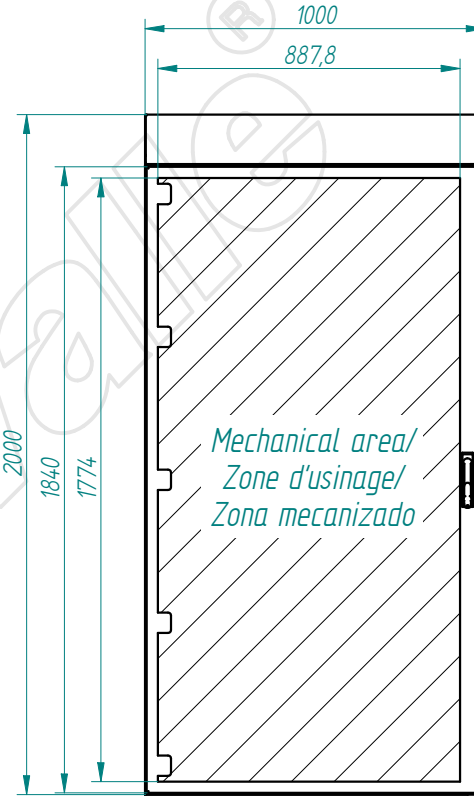

*Mechanical area/  
Zone d'usage/  
Zona mecanizado*

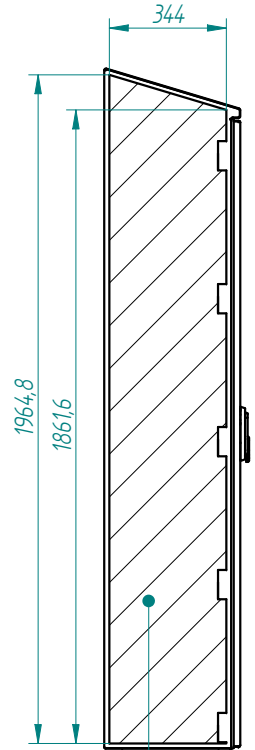



*Mechanical area/  
Zone d'usage/  
Zona mecanizado*

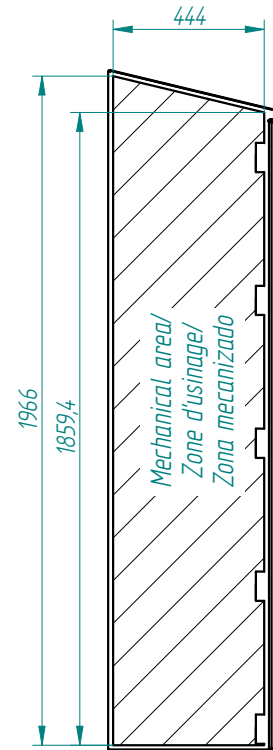
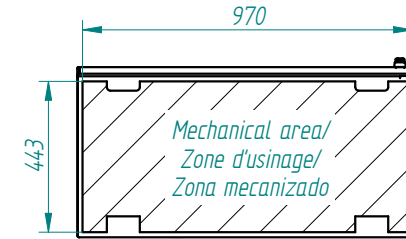
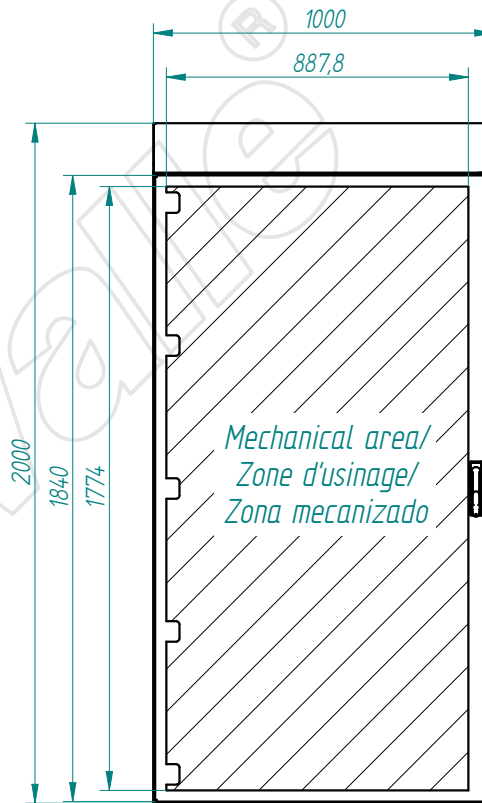
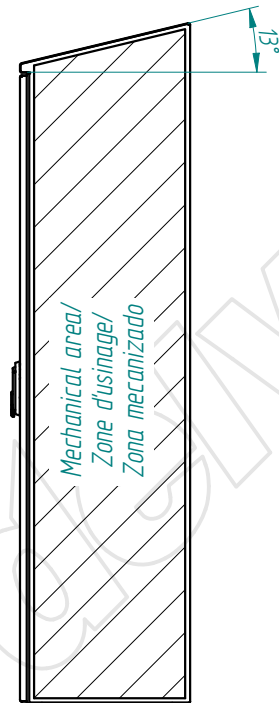
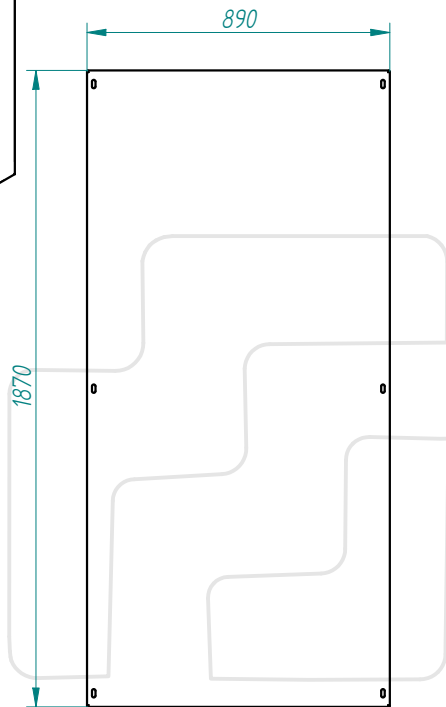
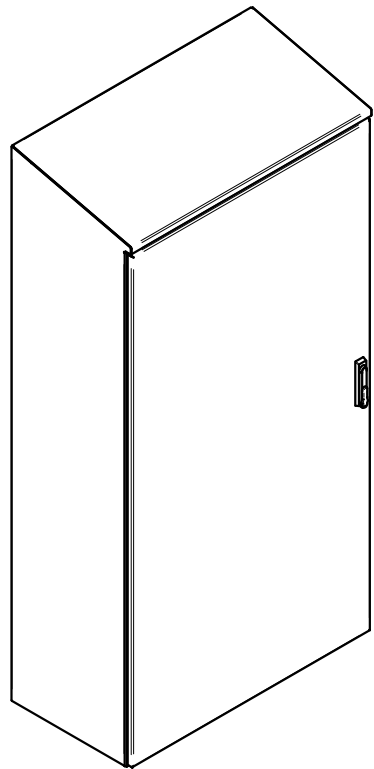

TOLERANCIA GENERAL DE MECANIZACION segun DIN 7168					Referencia:		FECHA: 28/05/2015	FIRMA: D.Martinez	
						DIBUJADO: 28/05/2015	D.Martinez		
	Creación del documento	28/05/2015	D.MTNEZ	A	-	APROBADO: 28/05/2015	D.Martinez		Nº PLANO:
	MODIFICACIONES	FECHA:	FIRMA:	REVISIÓN:	plegado: acabado:	DESIGNACIÓN: <b>tribeca higienic-2000x1000x400-estandar</b>			

This present document and its contents are confidential, and are the exclusive intellectual and / or industrial property of DEVALLE ., in addition to any technology, design, invention, work, process, know-how, calculation, manual, method, solution, idea, improvement, drawing, diagram, modification, contribution and, in short, any associated information or documentation involving industrial or intellectual property developed or supplied by DEVALLE on the occasion of the quote, order execution or incorporated into the design or operation of the supply. The recipient may not use such property in his favour or in that of a third party for purposes other than the fulfilment of the order and the operation and maintenance of the supply, without the prior written consent of DEVALLE. It is strictly forbidden to totally or partially reproduce this document and to misuse it and / or to show it to third parties. The infringing parties shall be required to pay the corresponding compensation for damages, and any other legal or criminal responsibilities, the infringement may give rise to.



TOLERANCIA GENERAL DE MECANIZACION segun DIN 7168					Referencia:  - plegado: acabado:	DIBUJADO:	FECHA:	FIRMA:	 Nº PLANO:	
						28/05/2015	D.Martinez	28/05/2015		D.Martinez
	Creación del documento	28/05/2015	D.MTNEZ	A		DESIGNACIÓN: tribeca hygienic-2000x1000x500-estandar				
	MODIFICACIONES	FECHA:	FIRMA:	REVISIÓN:						