

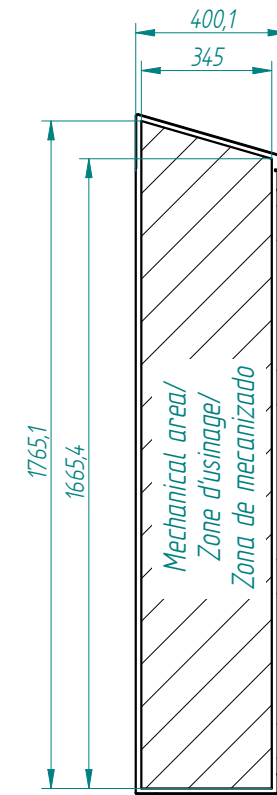

This present document and its contents are confidential, and are the exclusive intellectual and / or industrial property of DEVALLE. In addition to any technology, design, invention, work, process, know-how, calculation, manual, method, solution, idea, improvement, drawing, diagram, modification, contribution and, in short, any associated information involving industrial or intellectual property developed or supplied by DEVALLE on the occasion of the quote, order execution or incorporated into the design or operation of the supply. The recipient may not use such property in his favour or in that of a third party for purposes other than the fulfilment of the order and the operation and maintenance of the supply, without the prior written consent of DEVALLE. It is strictly forbidden to totally or partially reproduce this document and to misuse it or to show it to third parties. The infringing parties shall be required to pay the corresponding compensation for damages and any other legal or criminal responsibility. The infringement may give rise to.

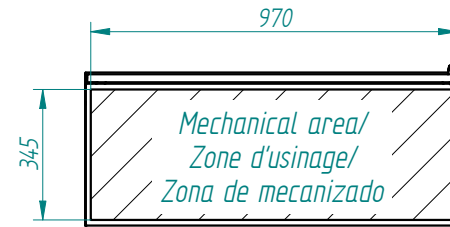

| | | | | | | | | | | |
|---|------------------------|------------|---------|-----------|--|--------------------------------------|------------|------------|--------------|---|
| TOLERANCIA GENERAL DE MECANIZACION según DIN 7168 | Creación del documento | 04/09/2014 | D.MTNEZ | A | Referencia: - plegado: acabado: | DIBUJADO: | 04/09/2014 | FIRMA: | D.Martínez |  |
| | MODIFICACIONES | FECHA: | FIRMA: | REVISIÓN: | | APROBADO: | 04/09/2014 | D.Martínez | DESIGNACIÓN: | |
| | | | | | | fresh tribeca-1650x1000x400-estandar | | | | |

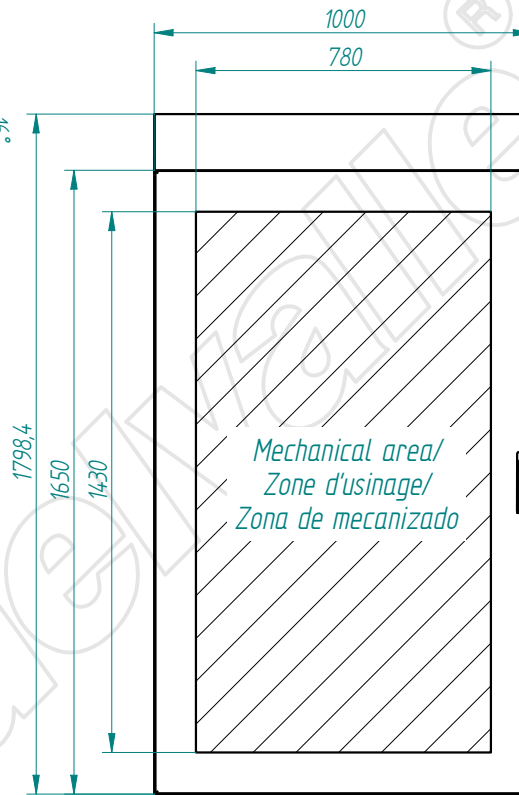
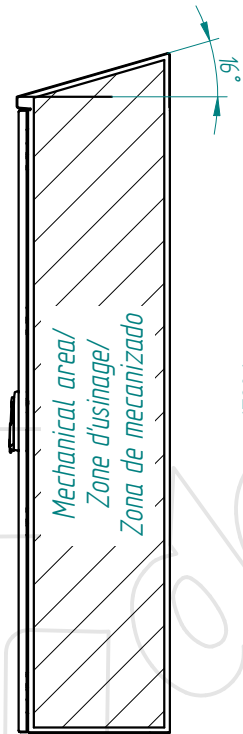
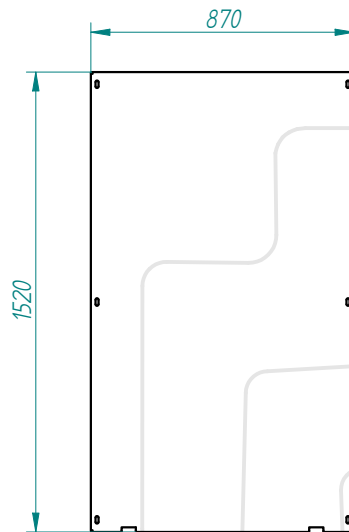
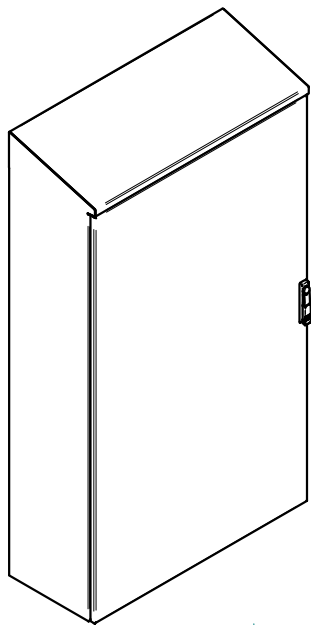

This present document and its contents are confidential, and are the exclusive intellectual and / or industrial property of DELVALLE. In addition to any technology, design, invention, work, process, know-how, calculation, manual, method, solution, idea, improvement, drawing, diagram, modification, contribution and, in short, any associated information or documentation involving industrial or intellectual property developed or supplied by DELVALLE on the occasion of the quote, order execution or incorporated into the design or operation of the supply. The recipient may not use such property in his favour or in that of a third party for purposes other than the fulfilment of the order and the operation and maintenance of the supply, without the prior written consent of DELVALLE. It is strictly forbidden to totally or partially reproduce this document and to misuse it and / or to show it to third parties. The infringing parties shall be required to pay the corresponding compensation for damages, and any other legal or criminal responsibility is the infringer's sole responsibility.

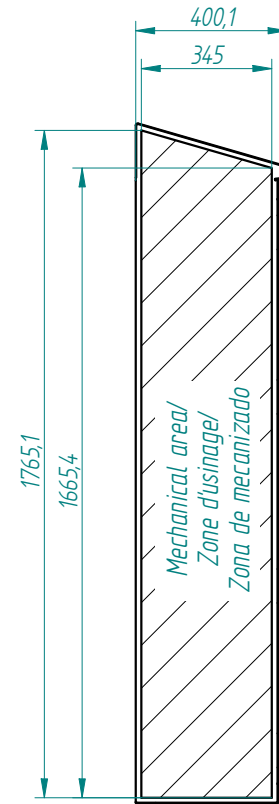
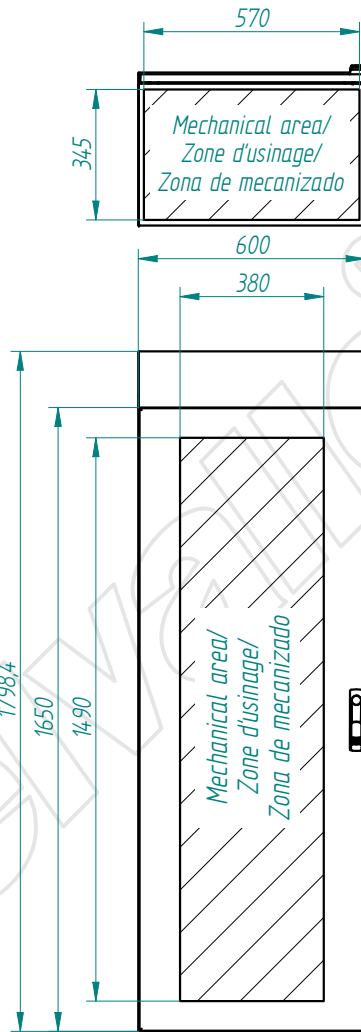
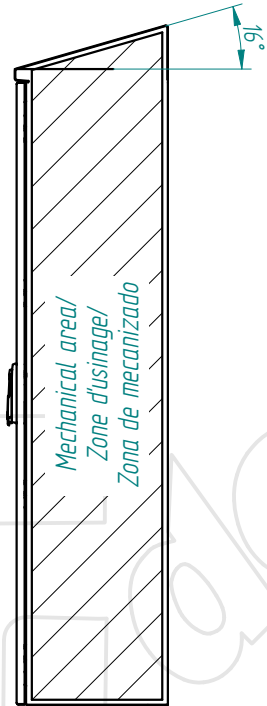
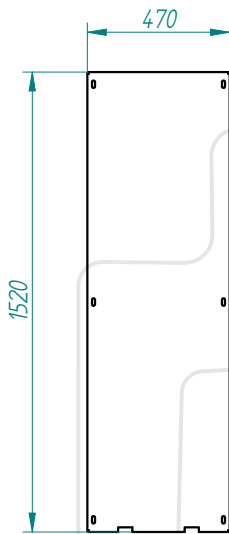
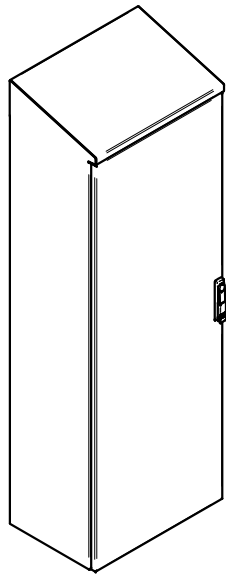

| | | | | | | | | | |
|---|------------------------|------------|---------|-----------|----------------------|-------------------------------------|------------|------------|---|
| TOLERANCIA GENERAL DE MECANIZACION según DIN 7168 | | | | | Referencia: | | FECHA: | FIRMA: |  |
| | | | | | | DIBUJADO: | 05/09/2014 | D.Martínez | |
| | | | | | | APROBADO: | 05/09/2014 | D.Martínez | |
| | Creación del documento | 05/09/2014 | D.MTNEZ | A | - | DESIGNACIÓN: | | | Nº PLANO: |
| | MODIFICACIONES | FECHA: | FIRMA: | REVISIÓN: | plegado: acabado: | fresh tribeca-1650x600x400-estandar | | | |

This present document and its contents are confidential, and are the exclusive intellectual and / or industrial property of DELVALLE. In addition to any technology, design, invention, work, process, know-how, calculation, manual, method, solution, idea, improvement, drawing, diagram, modification, contribution and, in short, any associated information or documentation involving industrial or intellectual property developed or supplied by DELVALLE on the occasion of the quote, order execution or incorporated into the design or operation of the supply. The recipient may not use such property in his favour or in that of a third party for purposes other than the fulfilment of the order and the operation and maintenance of the supply, without the prior written consent of DELVALLE. It is strictly forbidden to totally or partially reproduce this document and to misuse it and / or to show it to third parties. The infringing parties shall be required to pay the corresponding compensation for damages, and any other legal or criminal responsibility is the infringement may give rise to.

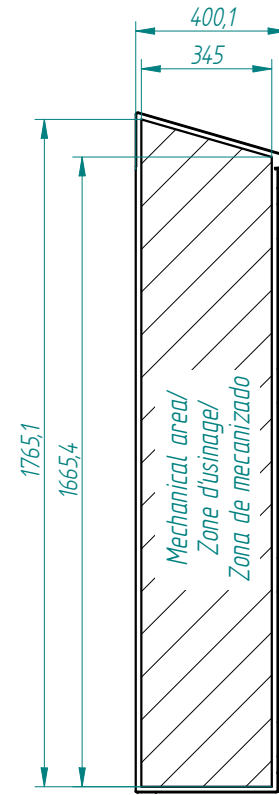
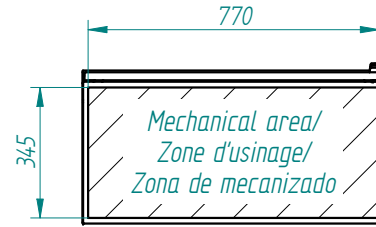
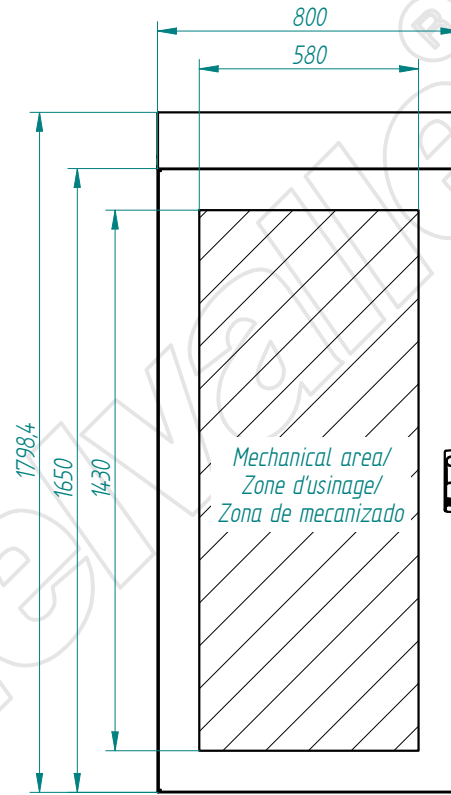
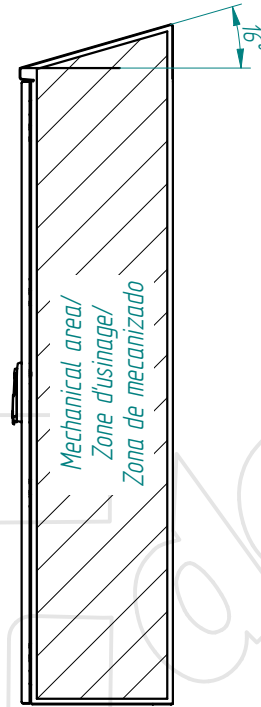
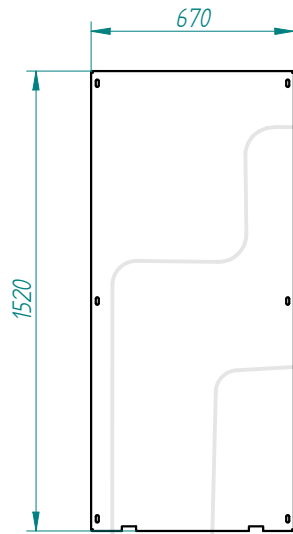
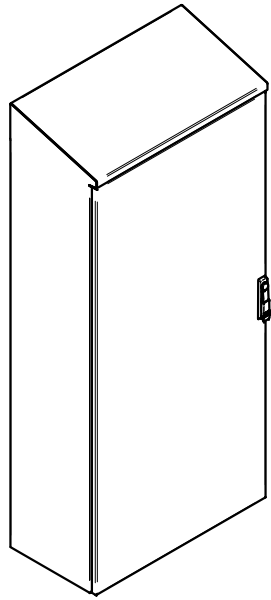

TOLERANCIA GENERAL DE MECANIZACION según DIN 7168

| | | | |
|------------------------|------------|---------|-----------|
| Creación del documento | 05/09/2014 | D.MTNEZ | A |
| MODIFICACIONES | FECHA: | FIRMA: | REVISIÓN: |

Referencia:

| | | | |
|--------------|-------------------------------------|--------|------------|
| DIBUJADO: | 05/09/2014 | FIRMA: | D.Martinez |
| APROBADO: | 05/09/2014 | FIRMA: | D.Martinez |
| DESIGNACIÓN: | fresh tribeca-1650x800x400-estandar | | |

Nº PLANO:



This present document and its contents are confidential, and are the exclusive intellectual and / or industrial property of DEVALLE. In addition to any technology, design, invention, work, process, know-how, calculation, manual, method, solution, idea, improvement, drawing, diagram, modification, contribution and, in short, any associated information or documentation involving industrial or intellectual property developed or supplied by DEVALLE on the occasion of the quote, order execution or incorporated into the design or operation of the supply. The recipient may not use such property in his favour or in that of a third party for purposes other than the fulfilment of the order and the operation and maintenance of the supply, without the prior written consent of DEVALLE. It is strictly forbidden to totally or partially reproduce this document and to misuse it and / or to show it to third parties. The infringing parties shall be required to pay the corresponding compensation for damages, and any other legal or criminal responsibility if the infringement may give rise to.

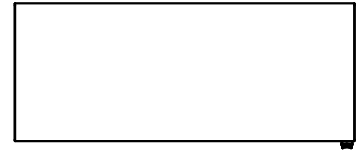
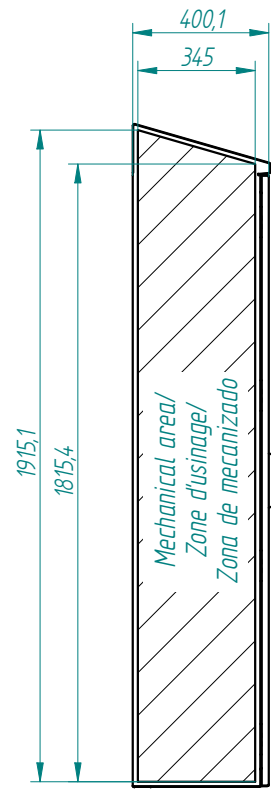
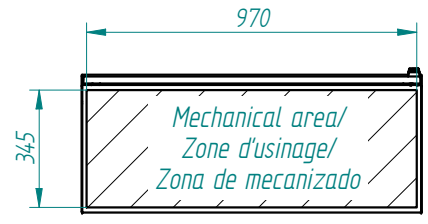
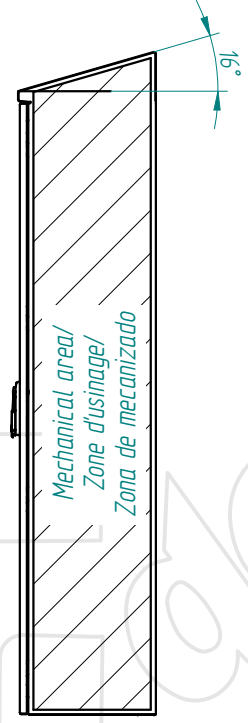
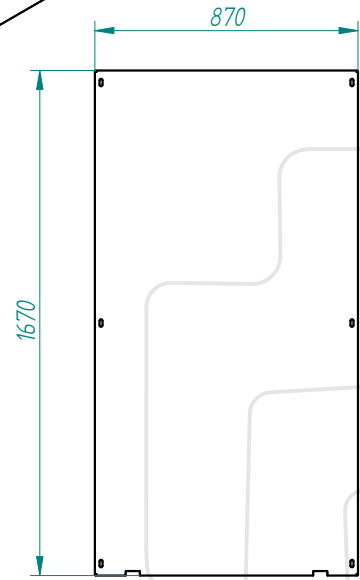
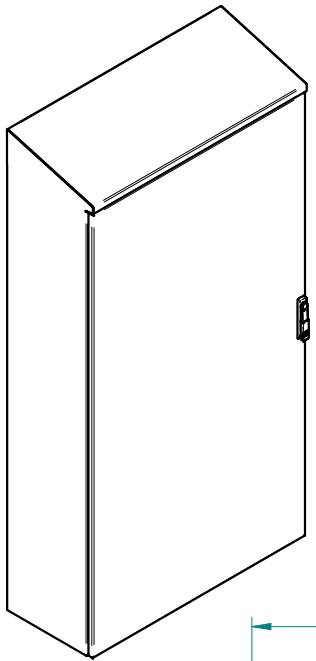



| | | | | |
|---|------------------------|------------|---------|-----------|
| TOLERANCIA GENERAL DE MECANIZACION según DIN 7168 | Creación del documento | 04/09/2014 | D.MTNEZ | A |
| | MODIFICACIONES | FECHA: | FIRMA: | REVISIÓN: |

| | | | |
|--------------------------------------|-----------|------------|------------|
| Referencia: | DIBUJADO: | FECHA: | FIRMA: |
| | APROBADO: | 04/09/2014 | D.Martinez |
| DESIGNACIÓN: | | | Nº PLANO: |
| fresh tribeca-1800x1000x400-estandar | | | |



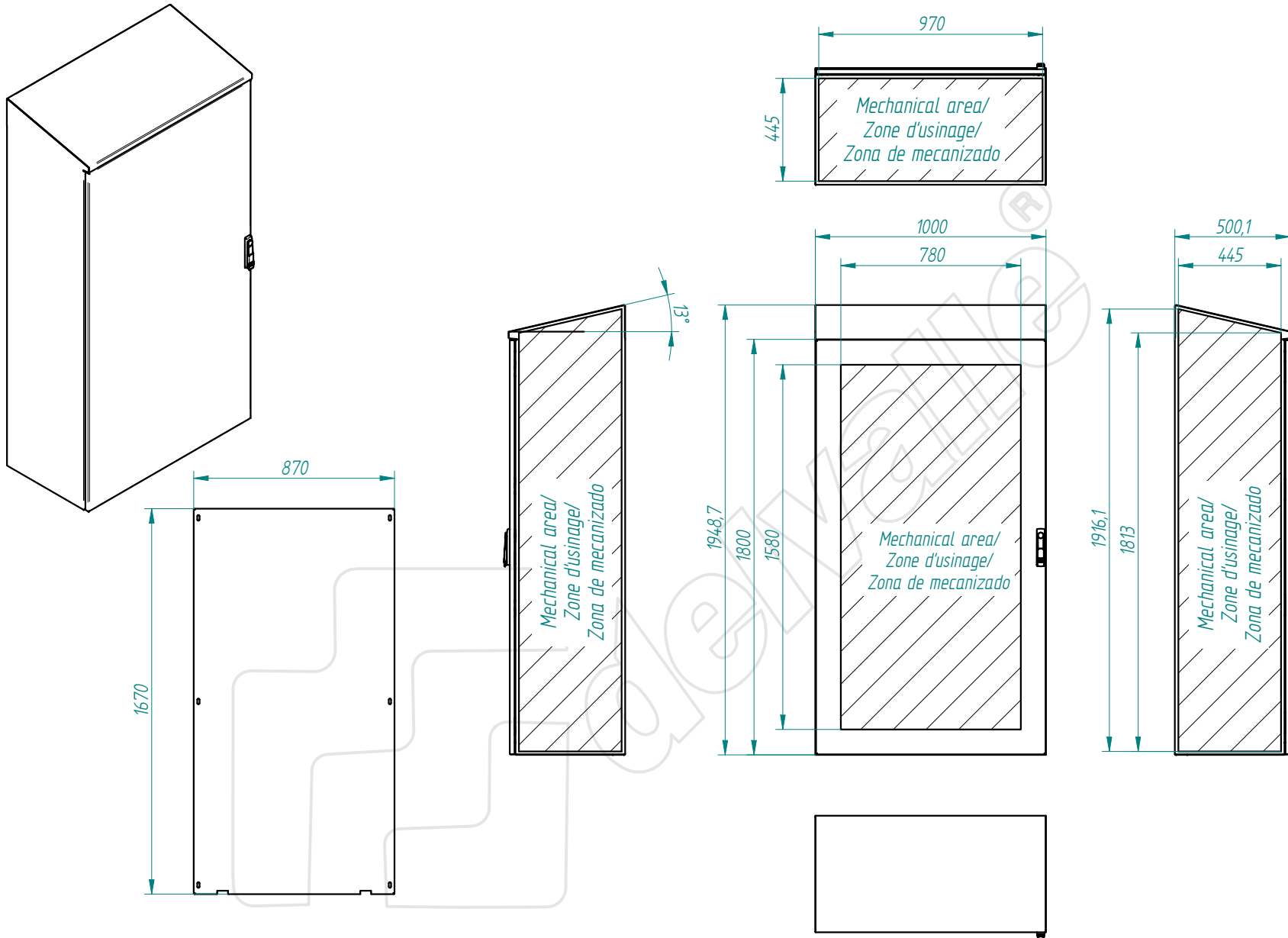

This present document and its contents are confidential, and are the exclusive intellectual and / or industrial property of DEVALLE. In addition to any technology, design, invention, work, process, know-how, calculation, manual, solution, idea, improvement, drawing, diagram, modification, contribution and, in short, any associated information involving industrial or intellectual property developed or supplied by DEVALLE on the occasion of the quote, order execution or incorporated into the design or operation of the supply. The recipient may not use such property in his favour or in that of a third party for purposes other than the fulfilment of the order and the operation and maintenance of the supply, without the prior written consent of DEVALLE. It is strictly forbidden to totally or partially reproduce this document and to misuse it and / or to show it to third parties. The infringing parties shall be required to pay the corresponding compensation for damages and any other legal or criminal responsibility. The infringement may give rise to.



| | | | | | | | | | | |
|---|------------------------|------------|---------|-----------|---|-----------|------------|------------|--------------|---|
| TOLERANCIA GENERAL DE MECANIZACION segun DIN 7168 | Creación del documento | 04/09/2014 | D.MTNEZ | A | Referencia: - plegado: - acabado: | DIBUJADO: | 04/09/2014 | FIRMA: | D.Martinez |  |
| | MODIFICACIONES | FECHA: | FIRMA: | REVISIÓN: | | APROBADO: | 04/09/2014 | D.Martinez | DESIGNACIÓN: | |

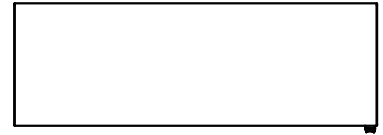
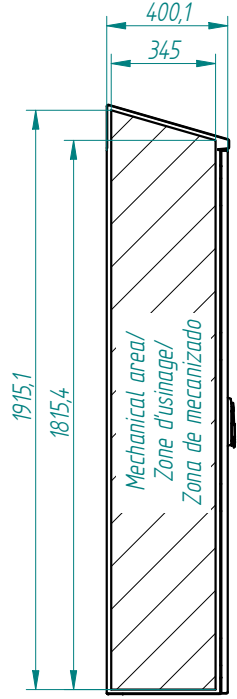
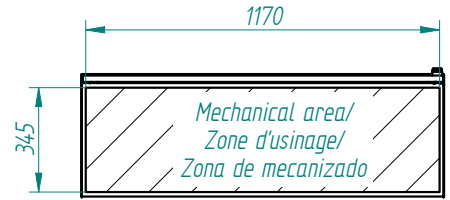
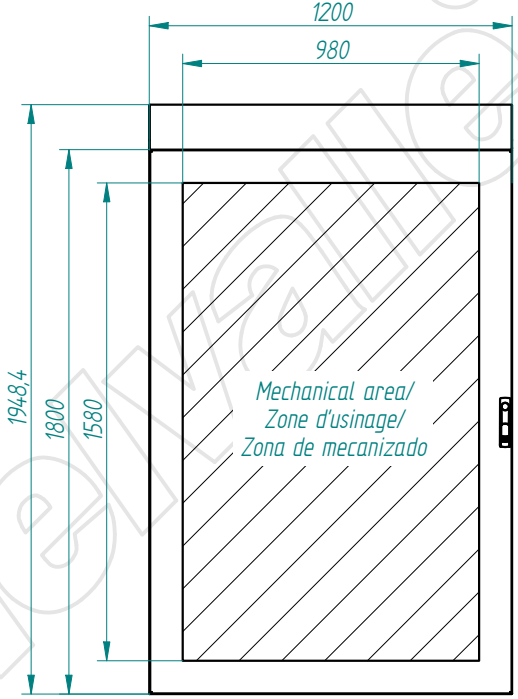
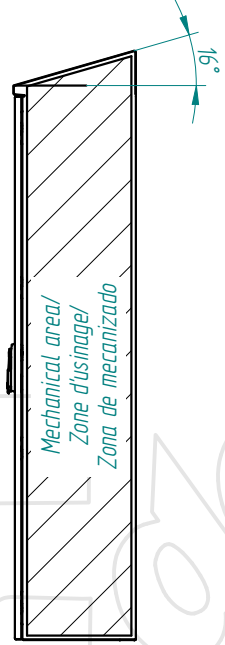
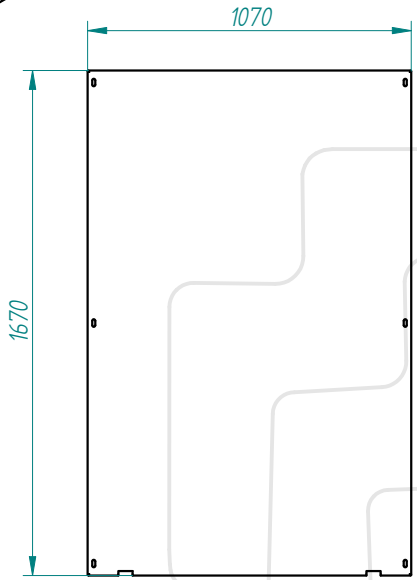
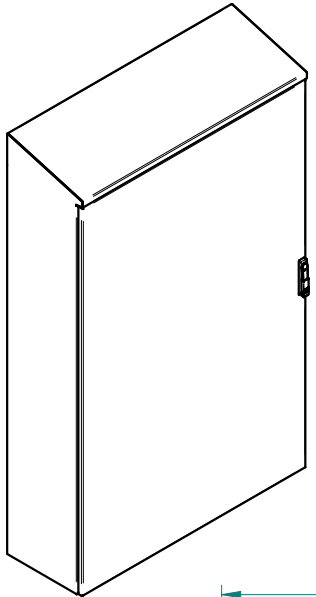

This present document and its contents are confidential, and are the exclusive intellectual and / or industrial property of DEVALLE. In addition to any technology, design, invention, work, process, know-how, calculation, manual, method, solution, idea, improvement, drawing, diagram, modification, contribution and, in short, any associated information or documentation involving industrial or intellectual property developed or supplied by DEVALLE on the occasion of the quote, order execution or incorporated into the design or operation of the supply. The recipient may not use such property in his favour or in that of a third party for purposes other than the fulfilment of the order and the operation and maintenance of the supply, without the prior written consent of DEVALLE. It is strictly forbidden to totally or partially reproduce this document and to misuse it and / or to show it to third parties. The infringing parties shall be required to pay the corresponding compensation for damages, and any other legal or criminal responsibility if the infringement may give rise to.



| | | | | |
|---|------------------------|------------|---------|-----------|
| TOLERANCIA GENERAL DE MECANIZACION según DIN 7168 | Creación del documento | 05/09/2014 | D.MTNEZ | A |
| | MODIFICACIONES | FECHA: | FIRMA: | REVISIÓN: |

| | | | | |
|--------------------------------------|-----------|------------|------------|------------|
| Referencia: | DIBUJADO: | 05/09/2014 | FIRMA: | D.Martinez |
| | APROBADO: | 05/09/2014 | D.Martinez | |
| DESIGNACIÓN: | | | | Nº PLANO: |
| fresh tribeca-1800x1200x400-estandar | | | | |



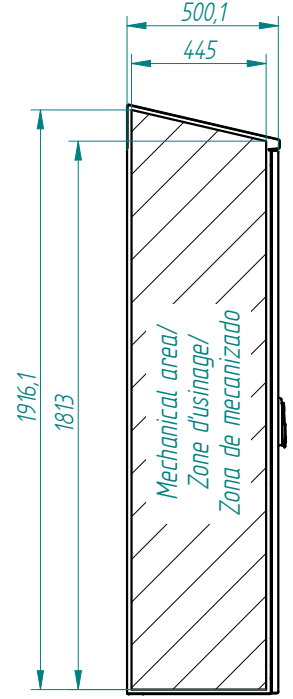
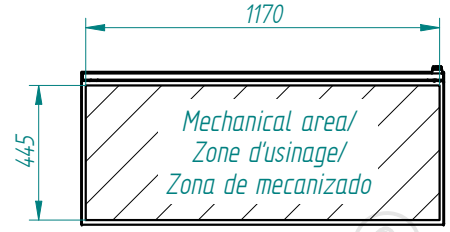
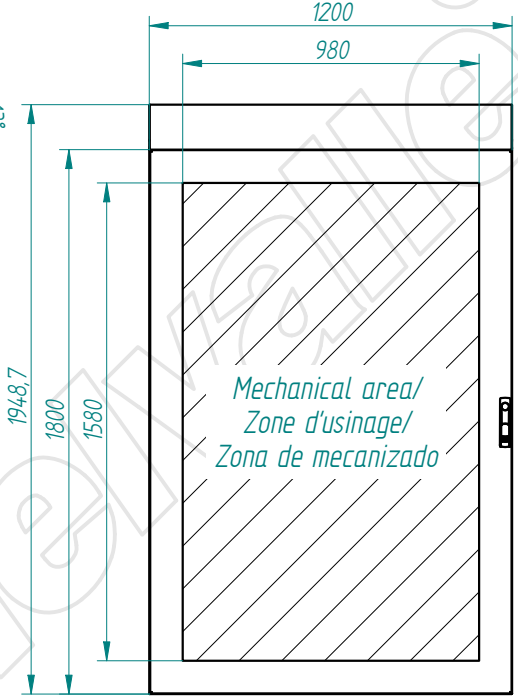
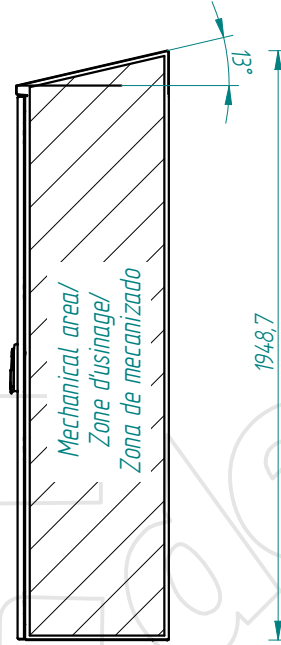
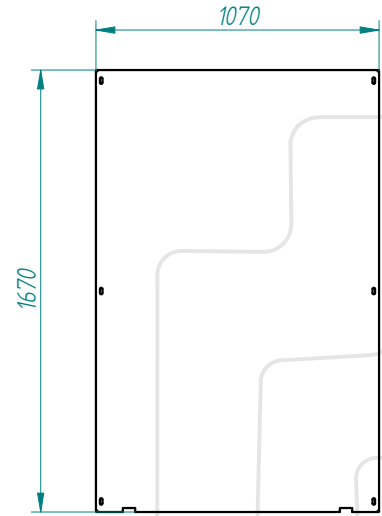
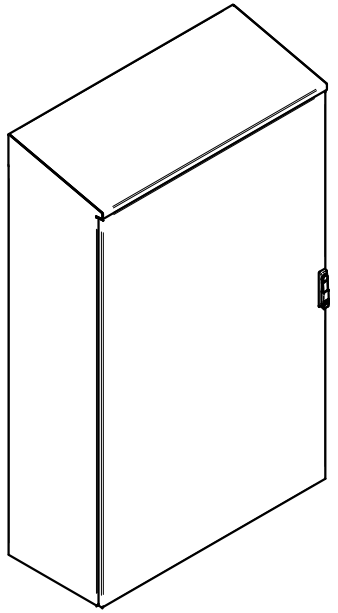

This present document and its contents are confidential, and are the exclusive intellectual and / or industrial property of DEVALLE. In addition to any technology, design, invention, work, process, know-how, calculation, manual, method, solution, idea, improvement, drawing, diagram, modification, contribution and, in short, any associated information or documentation involving industrial or intellectual property developed or supplied by DEVALLE on the occasion of the quote, order execution or incorporated into the design or operation of the supply. The recipient may not use such property in his favour or in that of a third party for purposes other than the fulfilment of the order and the operation and maintenance of the supply, without the prior written consent of DEVALLE. It is strictly forbidden to totally or partially reproduce this document and to misuse it and / or to show it to third parties. The infringing parties shall be required to pay the corresponding compensation for damages and any other legal or criminal responsibility. The infringement may give rise to.

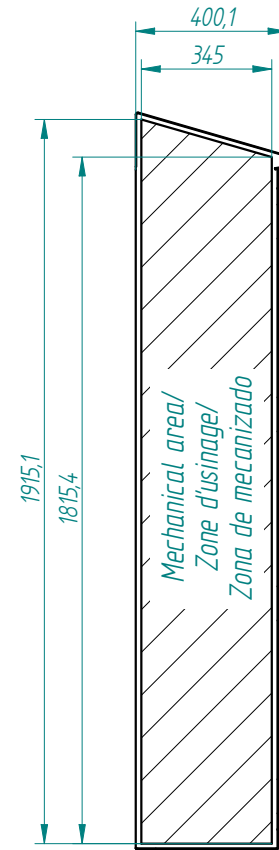
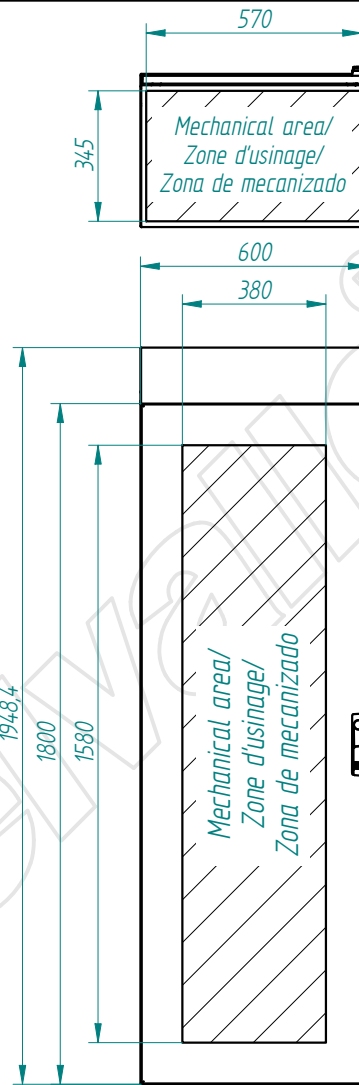
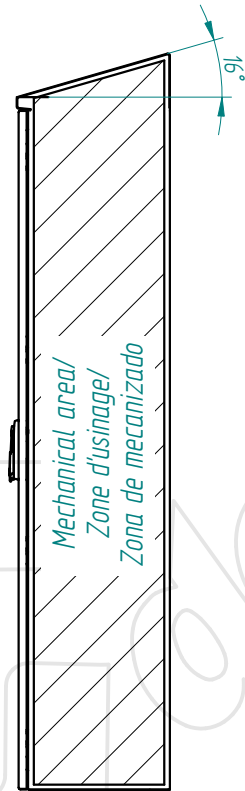
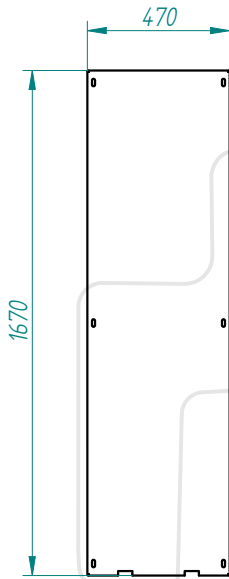
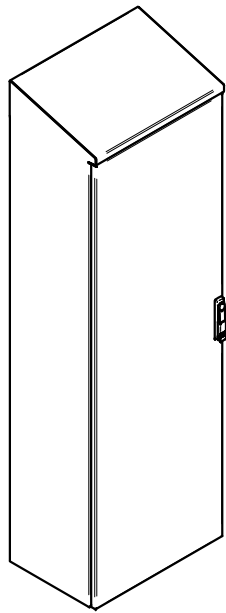

| | | | | | | | | | |
|---|------------------------|------------|---------|-----------|----------------------|--------------------------------------|------------|------------|-----------|
| TOLERANCIA GENERAL DE MECANIZACION según DIN 7168 | | | | | Referencia: | | FECHA: | FIRMA: | |
| | | | | | | DIBUJADO: | 05/09/2014 | D.Martínez | |
| | | | | | | APROBADO: | 05/09/2014 | D.Martínez | |
| | Creación del documento | 05/09/2014 | D.MTNEZ | A | - | DESIGNACIÓN: | | | Nº PLANO: |
| | MODIFICACIONES | FECHA: | FIRMA: | REVISIÓN: | plegado: acabado: | fresh tribeca-1800x1200x500-estandar | | | |

This present document and its contents are confidential, and are the exclusive intellectual and / or industrial property of DELVALLE. In addition to any technology, design, invention, work, process, know-how, calculation, manual, method, solution, idea, improvement, drawing, diagram, modification, contribution and, in short, any associated information or documentation involving industrial or intellectual property developed or supplied by DELVALLE on the occasion of the quote, order execution or incorporated into the design or operation of the supply. The recipient may not use such property in his favour or in that of a third party for purposes other than the fulfilment of the order and the operation and maintenance of the supply, without the prior written consent of DELVALLE. It is strictly forbidden to totally or partially reproduce this document and to misuse it and / or to show it to third parties. The infringing parties shall be required to pay the corresponding compensation for damages, and any other legal or criminal responsibility if the infringement may give rise to.



| | | | | | | | | | |
|---|------------------------|------------|---------|-----------|----------------------|-------------------------------------|------------|------------|---|
| TOLERANCIA GENERAL DE MECANIZACION según DIN 7168 | | | | | Referencia: | DIBUJADO: | FECHA: | FIRMA: |  |
| | | | | | | APROBADO: | 05/09/2014 | D.Martínez | |
| | Creación del documento | 05/09/2014 | D.MTNEZ | A | - | DESIGNACIÓN: | | | Nº PLANO: |
| | MODIFICACIONES | FECHA: | FIRMA: | REVISIÓN: | plegado: acabado: | fresh tribeca-1800x600x400-estandar | | | |

This present document and its contents are confidential, and are the exclusive intellectual and / or industrial property of DELVALLE. In addition to any technology, design, invention, work, process, know-how, calculation, manual, method, solution, idea, improvement, drawing, diagram, modification, contribution and, in short, any associated information or documentation involving industrial or intellectual property developed or supplied by DELVALLE on the occasion of the quote, order execution or incorporated into the design or operation of the supply. The recipient may not use such property in his favour or in that of a third party for purposes other than the fulfilment of the order and the operation and maintenance of the supply, without the prior written consent of DELVALLE. It is strictly forbidden to totally or partially reproduce this document and to misuse it and / or to show it to third parties. The infringing parties shall be required to pay the corresponding compensation for damages, and any other legal or criminal responsibility if the infringement may give rise to.

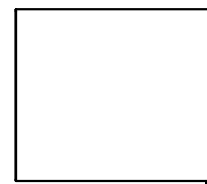
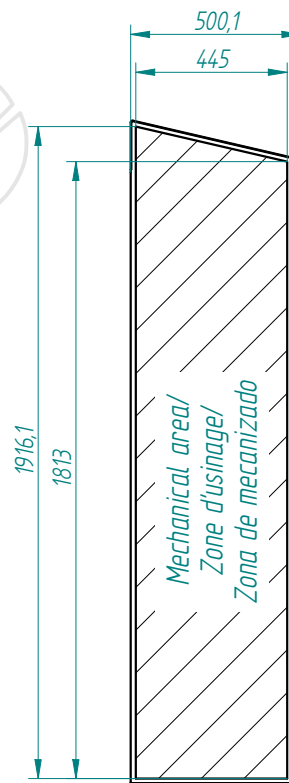
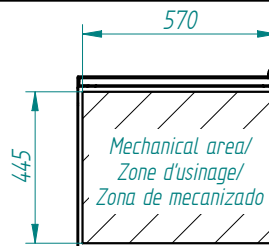
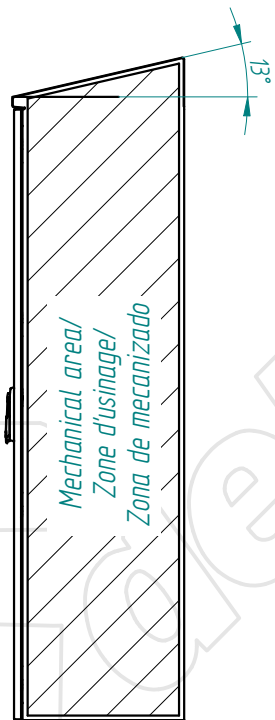
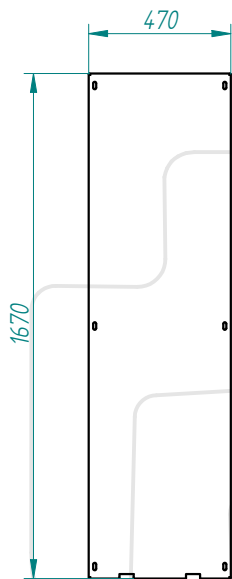
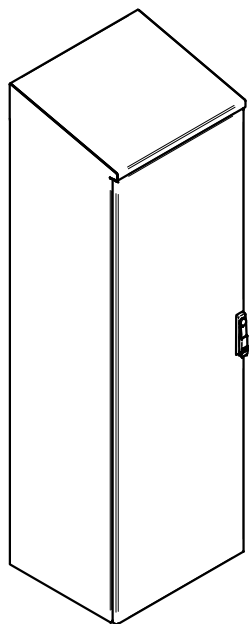

| | | | | | | | | | |
|---|------------------------|------------|---------|-----------|----------------------|--|------------|------------|---|
| TOLERANCIA GENERAL DE MECANIZACION según DIN 7168 | | | | | Referencia: | DIBUJADO: | FECHA: | FIRMA: |  |
| | | | | | | | 05/09/2014 | D.Martínez | |
| | Creación del documento | 05/09/2014 | D.MTNEZ | A | - | APROBADO: | 05/09/2014 | D.Martínez | Nº PLANO: |
| | MODIFICACIONES | FECHA: | FIRMA: | REVISIÓN: | plegado: acabado: | DESIGNACIÓN: fresh tribeca-1800x600x500-estandar | | | |

This present document and its contents are confidential, and are the exclusive intellectual and / or industrial property of DELVALLE. In addition to any technology, design, invention, work, process, know-how, calculation, manual, method, solution, idea, improvement, drawing, diagram, modification, contribution and, in short, any associated information involving industrial or intellectual property developed or supplied by DELVALLE on the occasion of the quote, order execution or incorporated into the design or operation of the supply. The recipient may not use such property in his favour or in that of a third party for purposes other than the fulfilment of the order and the operation and maintenance of the supply, without the prior written consent of DELVALLE. It is strictly forbidden to totally or partially reproduce this document and to misuse it and / or to show it to third parties. The infringing parties shall be required to pay the corresponding compensation for damages and any other legal or criminal responsibility. The infringement may give rise to.

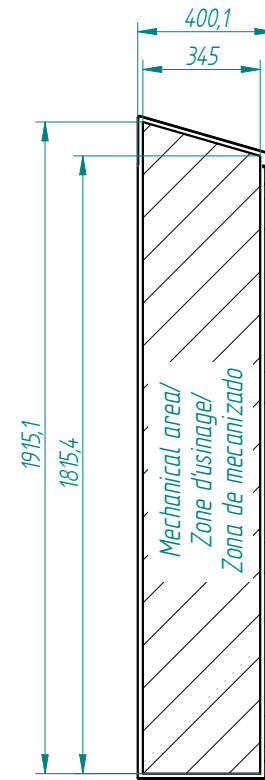
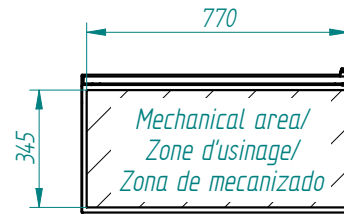
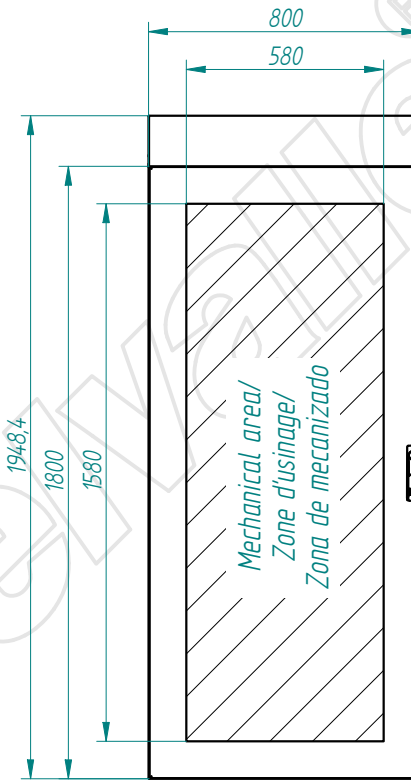
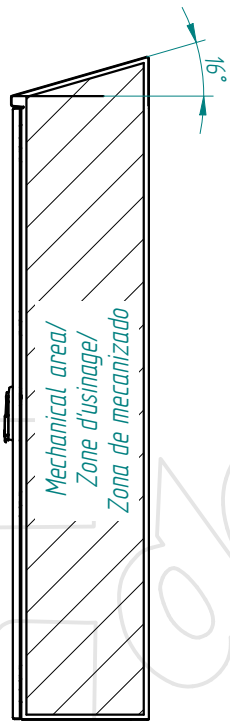
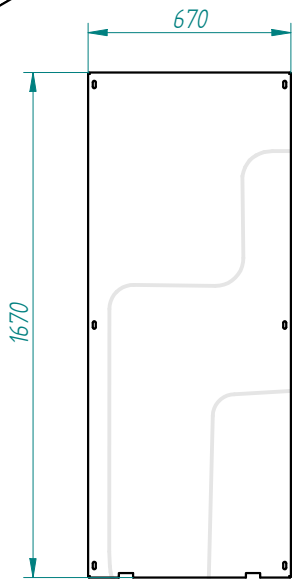
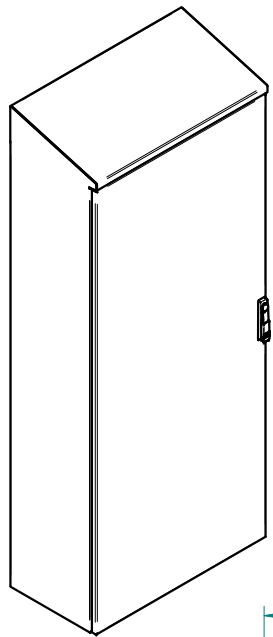

| | | | | | | | | | | |
|---|------------------------|------------|---------|-----------|---------------------------------------|--------------|-------------------------------------|------------|------------|--|
| TOLERANCIA GENERAL DE MECANIZACION según DIN 7168 | Creación del documento | 04/09/2014 | D.MTNEZ | A | Referencia: - plegado: acabado: | DIBUJADO: | 04/09/2014 | FIRMA: | D.Martínez |  Nº PLANO: |
| | MODIFICACIONES | FECHA: | FIRMA: | REVISIÓN: | | APROBADO: | 04/09/2014 | D.Martínez | | |
| | | | | | | DESIGNACIÓN: | Fresh Tribeca-1800x800x400-estandar | | | |

This present document and its contents are confidential, and are the exclusive intellectual and / or industrial property of DELVALLE ., in addition to any technology, design, invention, work, process, know-how, calculation, manual, method, solution, idea, improvement, drawing, diagram, modification, contribution and, in short, any associated information or documentation involving industrial or intellectual property developed or supplied by DELVALLE on the occasion of the quote, order execution or incorporated into the design or operation of the supply. The recipient may not use such property in his favour or in that of a third party for purposes other than the fulfilment of the order and the operation and maintenance of the supply, without the prior written consent of DELVALLE. It is strictly forbidden to totally or partially reproduce this document and to misuse it and / or to show it to third parties. The infringing parties shall be required to pay the corresponding compensation for damages, and any other legal or criminal responsibility if the infringement may give rise to.

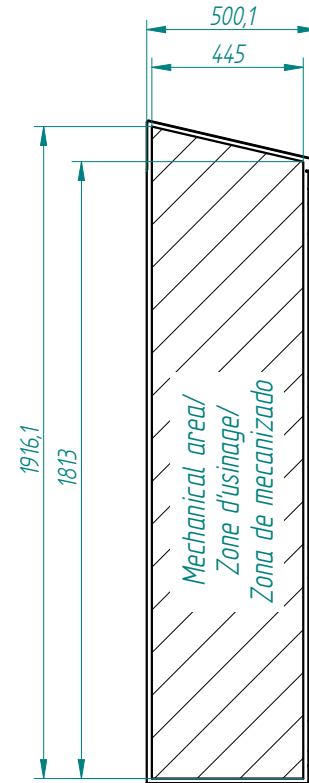
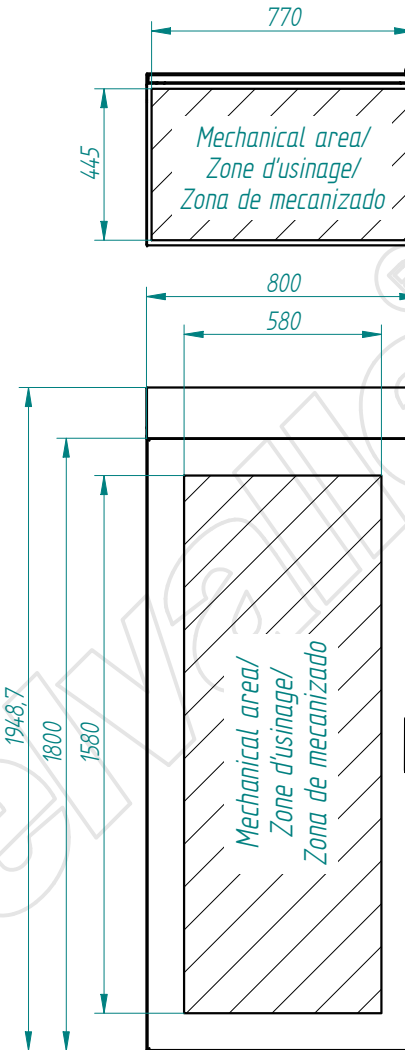
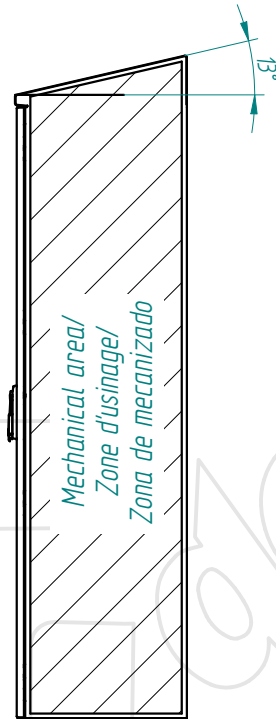
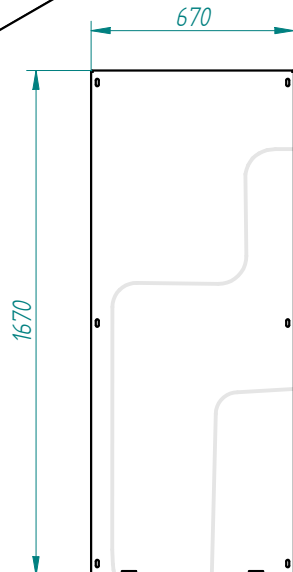
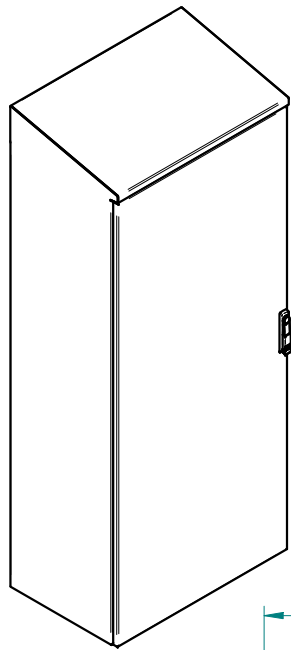

| | | | | | | | | | | |
|---|--|------------|---------|-----------|--|-----------|------------|------------|------------|--|
| TOLERANCIA GENERAL DE MECANIZACION según DIN 7168 | Creación del documento | 04/09/2014 | D.MTNEZ | A | Referencia: - plegado: acabado: | DIBUJADO: | 04/09/2014 | FIRMA: | D.Martinez |  N° PLANO: |
| | MODIFICACIONES | FECHA: | FIRMA: | REVISIÓN: | | APROBADO: | 04/09/2014 | D.Martinez | | |
| | DESIGNACIÓN: fresh tribeca-1800x800x500-estandar | | | | | | | | | |

This present document and its contents are confidential, and are the exclusive intellectual and / or industrial property of DEVALLE. In addition to any technology, design, invention, work, process, know-how, calculation, manual, method, solution, idea, improvement, drawing, diagram, modification, contribution and, in short, any associated information or documentation involving industrial or intellectual property developed or supplied by DEVALLE on the occasion of the quote, order execution or incorporated into the design or operation of the supply. The recipient may not use such property in his favour or in that of a third party for purposes other than the fulfilment of the order and the operation and maintenance of the supply, without the prior written consent of DEVALLE. It is strictly forbidden to totally or partially reproduce this document and to misuse it and / or to show it to third parties. The infringing parties shall be required to pay the corresponding compensation for damages, and any other legal or criminal responsibility is the infringement may give rise to.

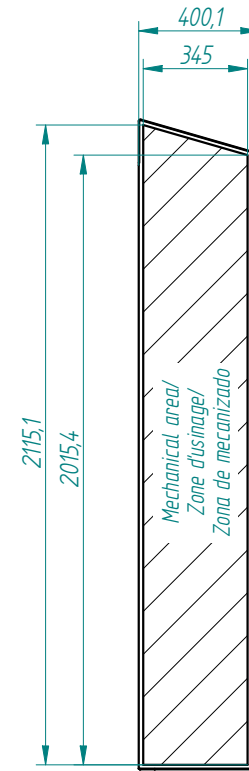
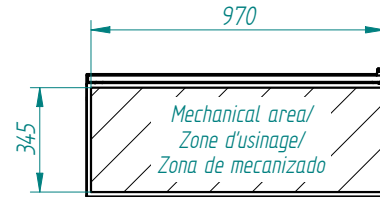
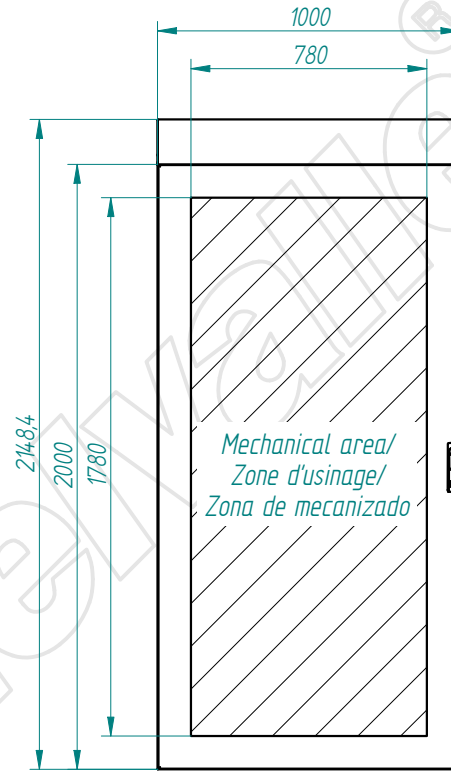
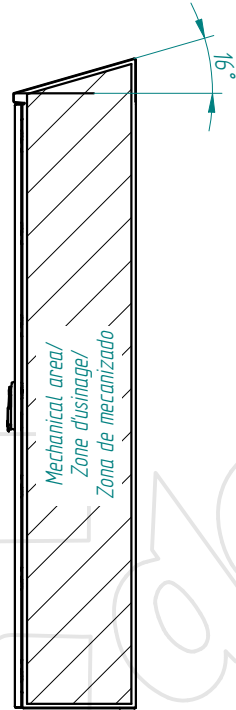
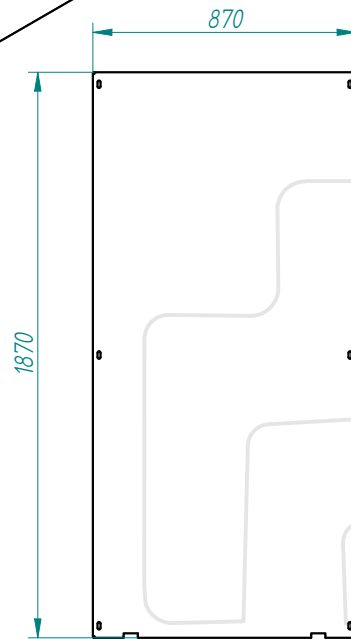
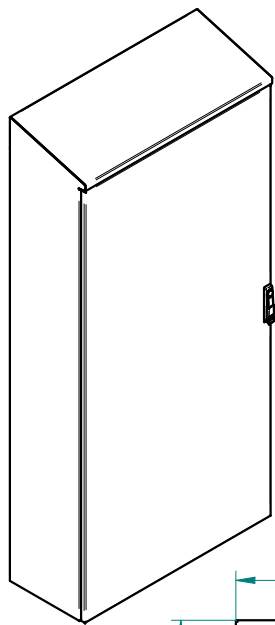

| | | | | | | | | |
|---|--|--|------------|-------------|-----------|--------------------------------------|--------|------------|
| TOLERANCIA GENERAL DE MECANIZACION segun DIN 7168 | | | | Referencia: | | | | |
| | | | | | DIBUJADO: | 05/09/2014 | FIRMA: | D.Martinez |
| | | | | | APROBADO: | 05/09/2014 | FIRMA: | D.Martinez |
| Creación del documento | | | 05/09/2014 | D.MTNEZ | A | DESIGNACIÓN: | | Nº PLANO: |
| MODIFICACIONES | | | FECHA: | FIRMA: | REVISIÓN: | fresh tribeca-2000x1000x400-estandar | | |



This present document and its contents are confidential, and are the exclusive intellectual and / or industrial property of DEVALLE. In addition to any technology, design, invention, work, process, know-how, calculation, manual, method, solution, idea, improvement, drawing, diagram, modification, contribution and, in short, any associated information or documentation involving industrial or intellectual property developed or supplied by DEVALLE on the occasion of the quote, order execution or incorporated into the design or operation of the supply. The recipient may not use such property in his favour or in that of a third party for purposes other than the fulfilment of the order and the operation and maintenance of the supply, without the prior written consent of DEVALLE. It is strictly forbidden to totally or partially reproduce this document and to misuse it or to show it to third parties. The infringing parties shall be required to pay the corresponding compensation for damages and any other legal or criminal responsibility. The infringement may give rise to.

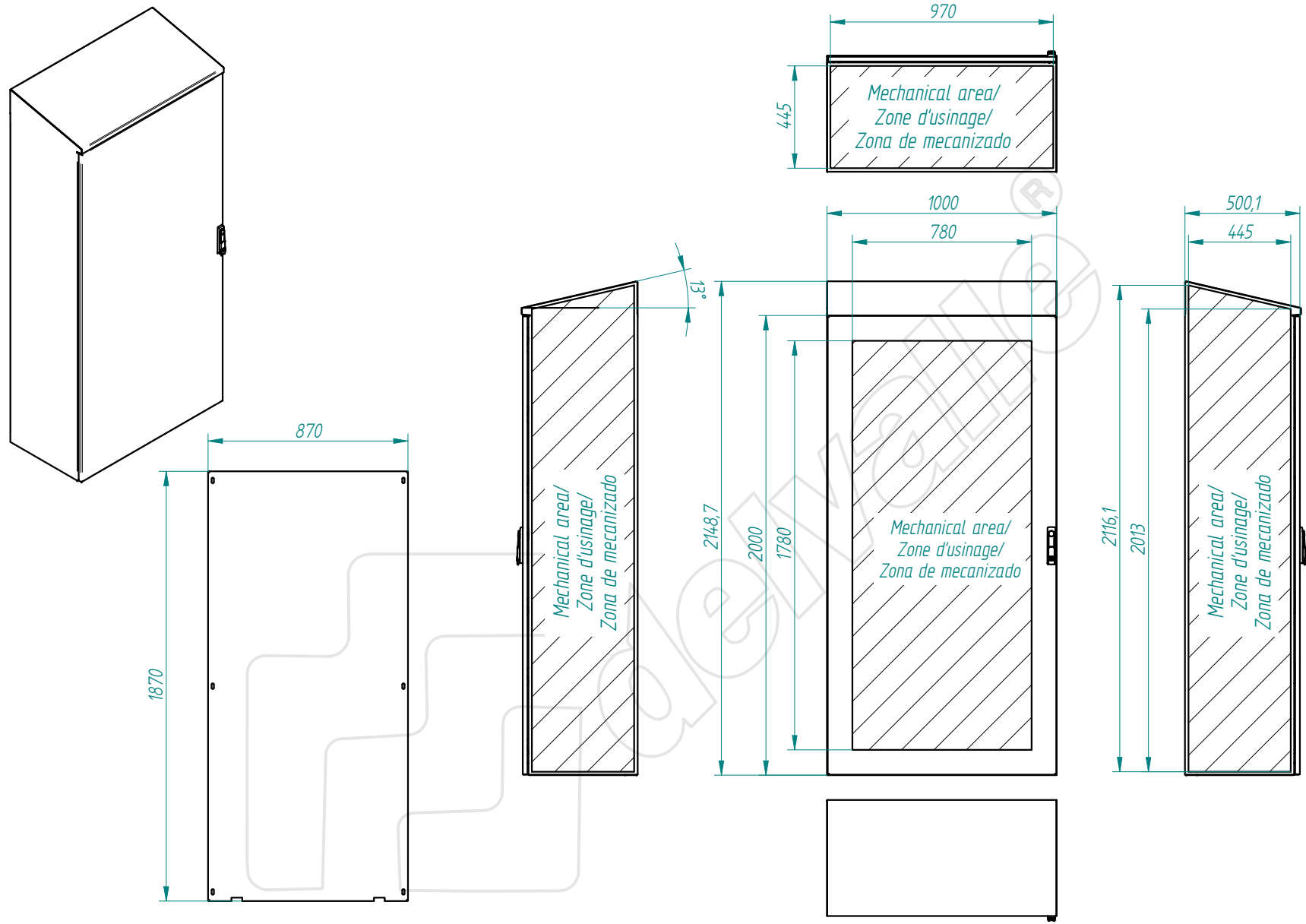

| | | | | | | | | | |
|---|------------------------|------------|---------|-----------|----------------------|--------------------------------------|------------|------------|--|
| TOLERANCIA GENERAL DE MECANIZACION segun DIN 7168 | | | | | Referencia: | | FECHA: | FIRMA: | |
| | | | | | | DIBUJADO: | 08/09/2014 | D.Martinez | |
| | | | | | | APROBADO: | 08/09/2014 | D.Martinez | |
| | Creación del documento | 08/09/2014 | D.MTNEZ | A | - | DESIGNACIÓN: | | Nº PLANO: | |
| | MODIFICACIONES | FECHA: | FIRMA: | REVISIÓN: | plegado: acabado: | fresh tribeca-2000x1000x500-estandar | | | |

This present document and its contents are confidential, and are the exclusive intellectual and / or industrial property of DEVALLE. In addition to any technology, design, invention, work, process, know-how, calculation, manual, method, solution, idea, improvement, drawing, diagram, modification, contribution and, in short, any associated information or documentation involving industrial or intellectual property developed or supplied by DEVALLE on the occasion of the quote, order execution or incorporated into the design or operation of the supply. The recipient may not use such property in his favour or in that of a third party for purposes other than the fulfilment of the order and the operation and maintenance of the supply, without the prior written consent of DEVALLE. It is strictly forbidden to totally or partially reproduce this document and to misuse it and / or to show it to third parties. The infringing parties shall be required to pay the corresponding compensation for damages and any other legal or criminal responsibility. The infringement may give rise to.

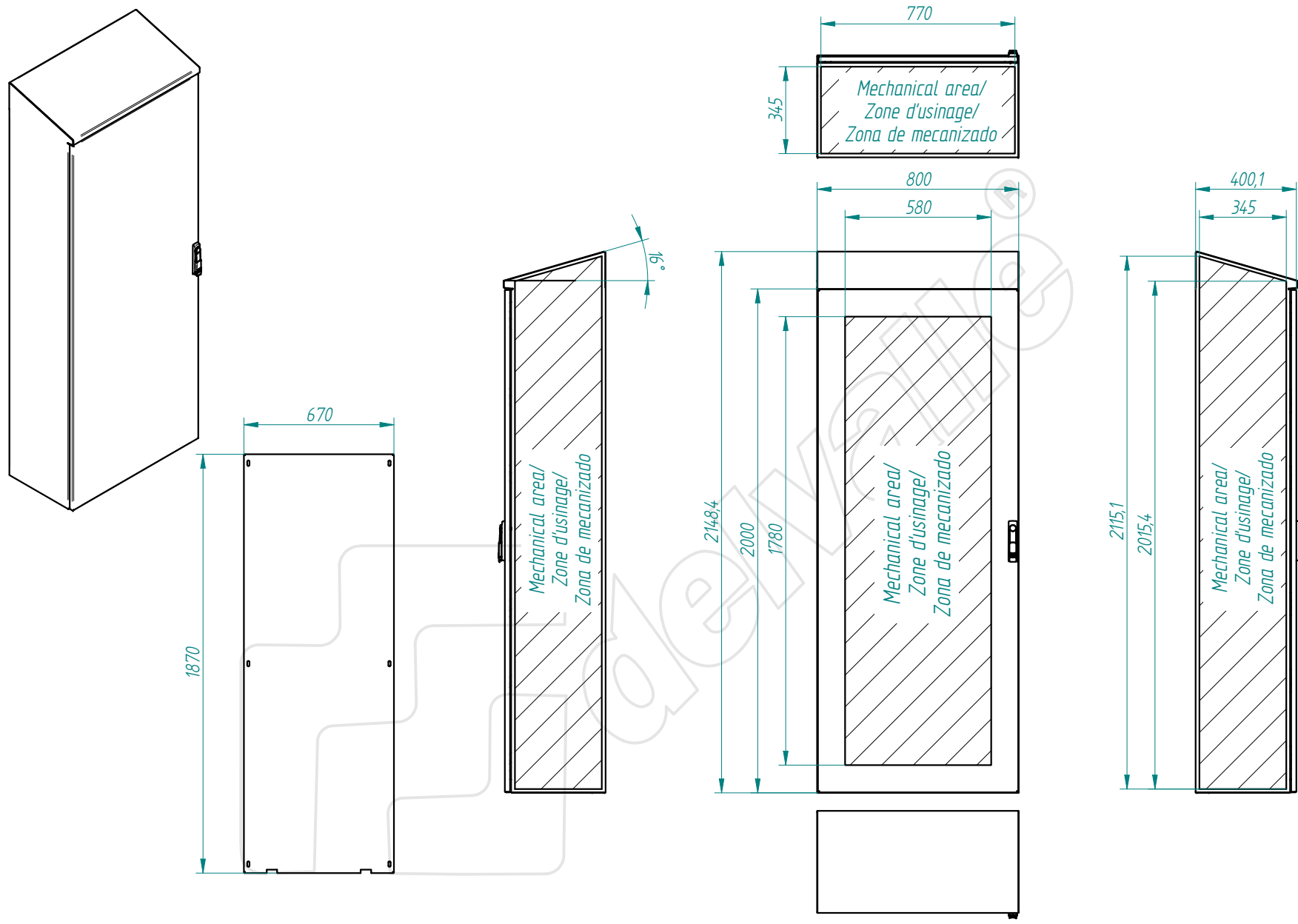

| | | | | |
|---|------------------------|------------|---------|-----------|
| TOLERANCIA GENERAL DE MECANIZACION segun DIN 7168 | Creación del documento | 05/09/2014 | D.MTNEZ | A |
| | MODIFICACIONES | FECHA: | FIRMA: | REVISIÓN: |

Referencia:
- plegado:
- acabado:

| | | | |
|-------------------------------------|------------|-----------|------------|
| DIBUJADO: | 05/09/2014 | FIRMA: | D.Martinez |
| APROBADO: | 05/09/2014 | FIRMA: | D.Martinez |
| DESIGNACIÓN: | | Nº PLANO: | |
| Fresh Tribeca-2000x800x400-estandar | | | |



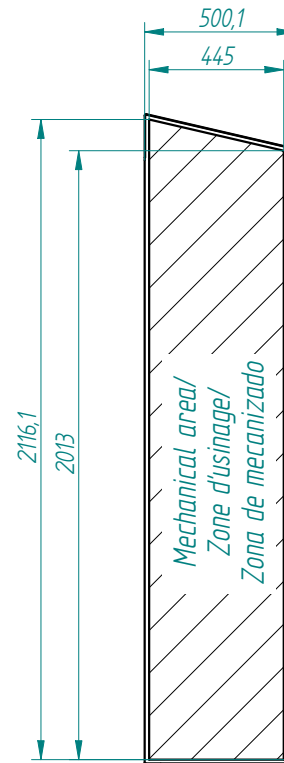
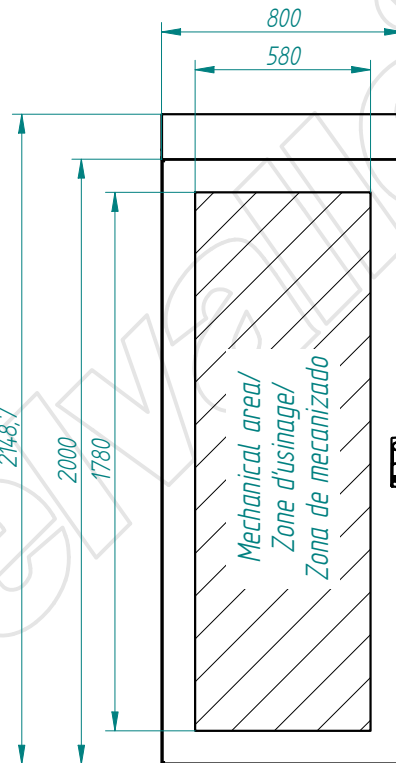
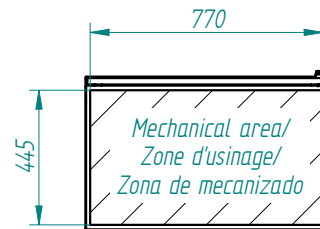
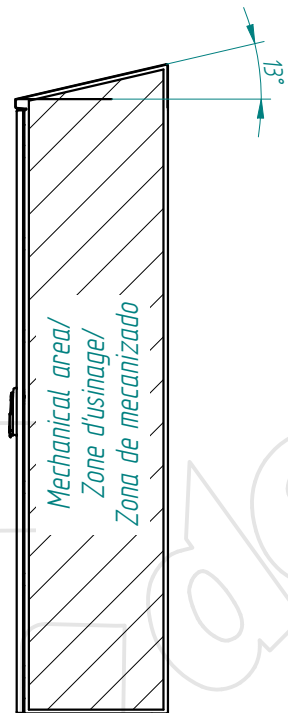
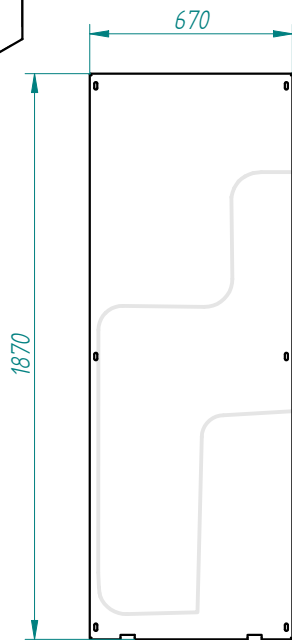
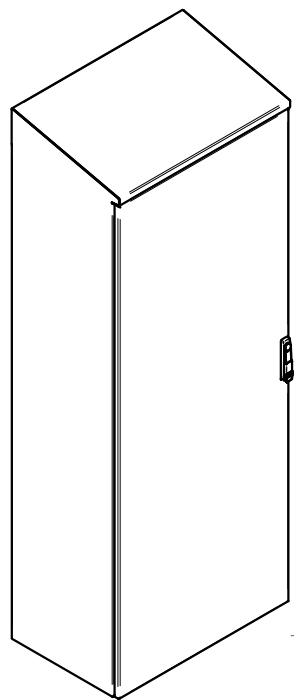

This present document and its contents are confidential, and are the exclusive intellectual and / or industrial property of DEVALLE... in addition to any technology, design, invention, work, process, know-how, calculation, manual, method, solution, idea, improvement, drawing, diagram, modification, contribution and, in short, any associated information or documentation involving industrial or intellectual property developed or supplied by DEVALLE on the occasion of the quote, order execution or incorporated into the design or operation of the supply. The recipient may not use such property in his favour or in that of a third party for purposes other than the fulfilment of the order and the operation and maintenance of the supply, without the prior written consent of DEVALLE. It is strictly forbidden to totally or partially reproduce this document and to misuse it and / or to show it to third parties. The infringing parties shall be required to pay the corresponding compensation for damages and any other legal or criminal responsibility & the infringement may give rise to.

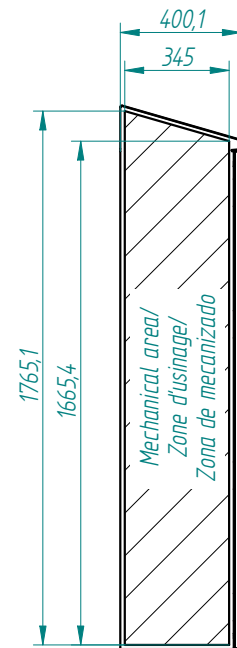
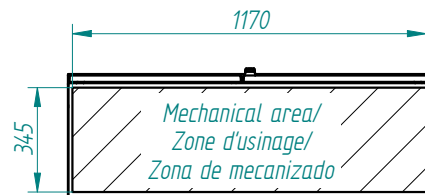
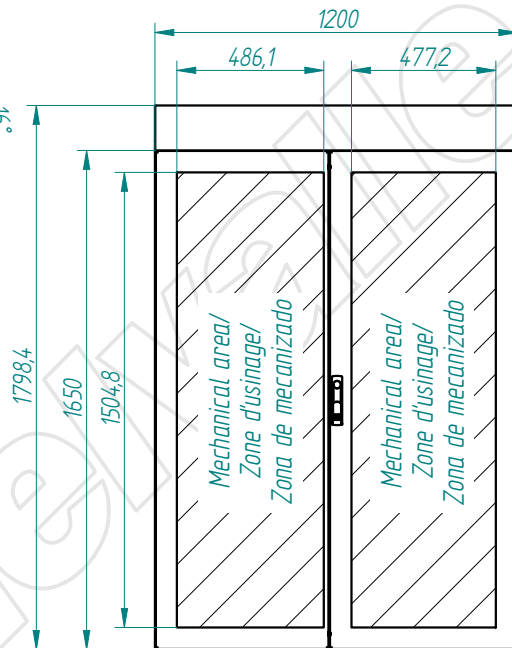
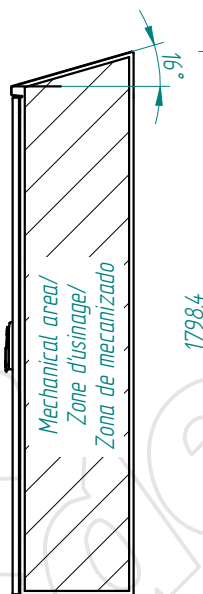
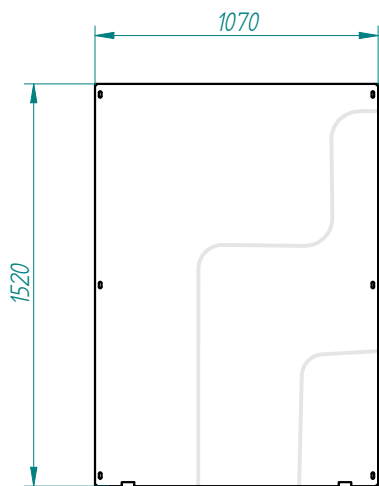
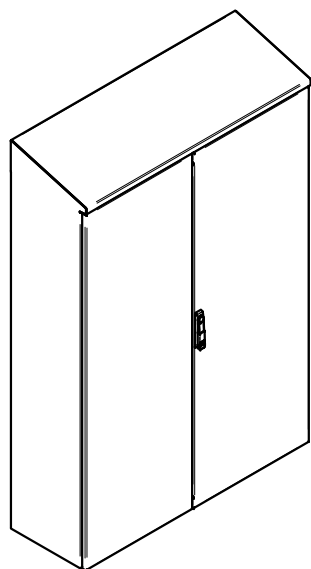

| | | | | | | | | | |
|---|------------------------|------------|---------|-----------|----------------------|-------------------------------------|------------|------------|---|
| TOLERANCIA GENERAL DE MECANIZACION según DIN 7168 | | | | | Referencia: | | FECHA: | FIRMA: |  |
| | | | | | | DIBUJADO: | 05/09/2014 | D.Martínez | |
| | | | | | | APROBADO: | 05/09/2014 | D.Martínez | |
| | Creación del documento | 05/09/2014 | D.MTNEZ | A | - | DESIGNACIÓN: | | | Nº PLANO: |
| | MODIFICACIONES | FECHA: | FIRMA: | REVISIÓN: | plegado: acabado: | Fresh Tribeca-2000x800x500-estandar | | | |

This present document and its contents are confidential, and are the exclusive intellectual and / or industrial property of DEVALLE. In addition to any technology, design, invention, work, process, know-how, calculation, manual, method, solution, idea, improvement, drawing, diagram, modification, contribution and, in short, any associated information or documentation involving industrial or intellectual property developed or supplied by DEVALLE on the occasion of the quote, order execution or incorporated into the design or operation of the supply. The recipient may not use such property in his favour or in that of a third party for purposes other than the fulfilment of the order and the operation and maintenance of the supply, without the prior written consent of DEVALLE. It is strictly forbidden to totally or partially reproduce this document and to misuse it and / or to show it to third parties. The infringing parties shall be required to pay the corresponding compensation for damages and any other legal or criminal responsibility. The infringement may give rise to.



| | | | | | | | | | |
|---|------------------------|------------|---------|-----------|----------------------|---|------------|------------|---|
| TOLERANCIA GENERAL DE MECANIZACION según DIN 7168 | | | | | Referencia: | | FECHA: | FIRMA: |  |
| | | | | | | DIBUJADO: | 05/09/2014 | D.Martínez | |
| | | | | | | APROBADO: | 05/09/2014 | D.Martínez | |
| | Creación del documento | 05/09/2014 | D.MTNEZ | A | - | DESIGNACIÓN: | | Nº PLANO: | |
| | MODIFICACIONES | FECHA: | FIRMA: | REVISIÓN: | plegado: acabado: | fresh tribeca 2p-1650x1200x400-estandar | | | |



This present document and its contents are confidential, and are the exclusive intellectual and / or industrial property of DEVALLE. In addition to any technology, design, invention, work, process, know-how, calculation, manual, method, solution, idea, improvement, drawing, diagram, modification, contribution and, in short, any associated information or documentation involving industrial or intellectual property developed or supplied by DEVALLE on the occasion of the quote, order execution or incorporated into the design or operation of the supply. The recipient may not use such property in his favour or in that of a third party for purposes other than the fulfilment of the order and the operation and maintenance of the supply, without the prior written consent of DEVALLE. It is strictly forbidden to totally or partially reproduce this document and to misuse it and / or to show it to third parties. The infringing parties shall be required to pay the corresponding compensation for damages, and any other legal or criminal responsibility is the infringement may give rise to.

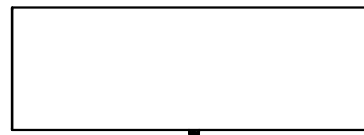
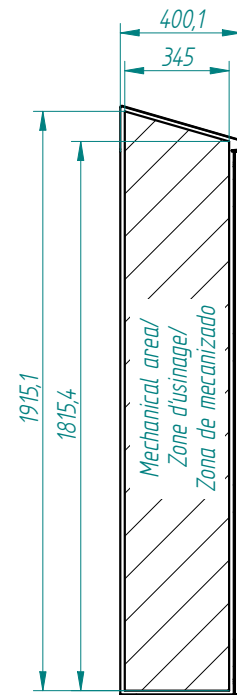
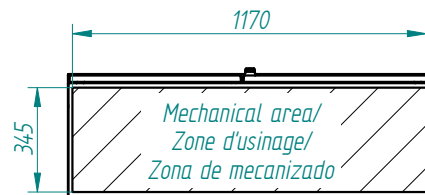
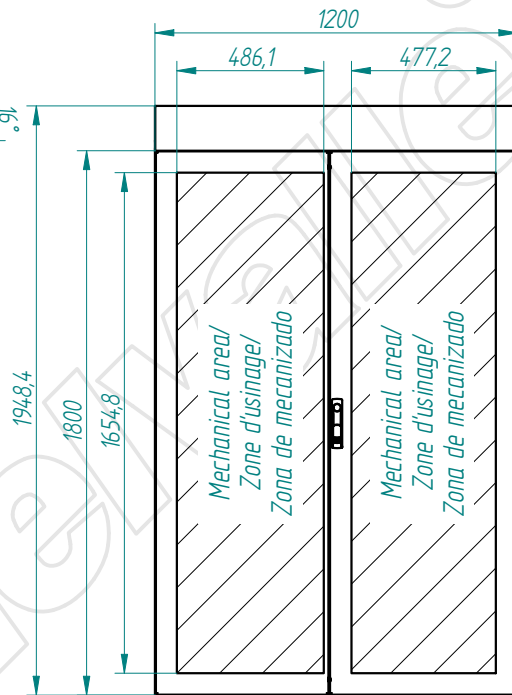
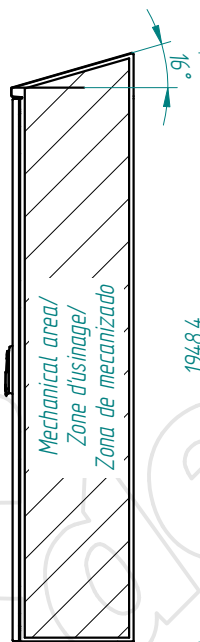
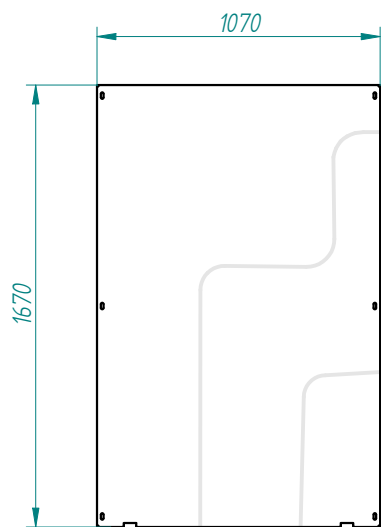
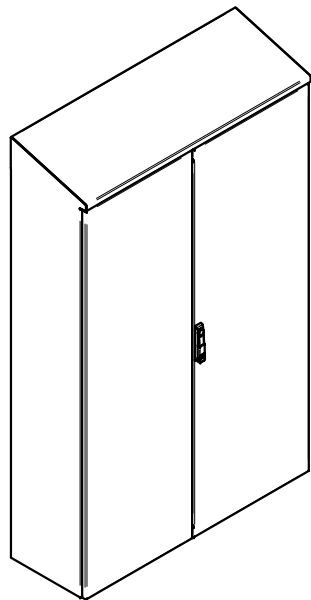

TOLERANCIA GENERAL DE MECANIZACION según DIN 7168

| | | | |
|------------------------|------------|---------|-----------|
| Creación del documento | 05/09/2014 | D.MTNEZ | A |
| MODIFICACIONES | FECHA: | FIRMA: | REVISIÓN: |

Referencia:

| | | | |
|--------------|---|--------|------------|
| DIBUJADO: | 05/09/2014 | FIRMA: | D.Martinez |
| APROBADO: | 05/09/2014 | FIRMA: | D.Martinez |
| DESIGNACIÓN: | fresh tribeca 2p-1800x1200x400-estandar | | |

Nº PLANO:



This present document and its contents are confidential, and are the exclusive intellectual and / or industrial property of DEVALLE. In addition to any technology, design, invention, work, process, know-how, calculation, manual, method, solution, idea, improvement, drawing, diagram, modification, contribution and, in short, any associated information or documentation involving industrial or intellectual property developed or supplied by DEVALLE on the occasion of the quote, order execution or incorporated into the design or operation of the supply. The recipient may not use such property in his favour or in that of a third party for purposes other than the fulfilment of the order and the operation and maintenance of the supply, without the prior written consent of DEVALLE. It is strictly forbidden to totally or partially reproduce this document and to misuse it and / or to show it to third parties. The infringing parties shall be required to pay the corresponding compensation for damages, and any other legal or criminal responsibility is the infringement may give rise to.

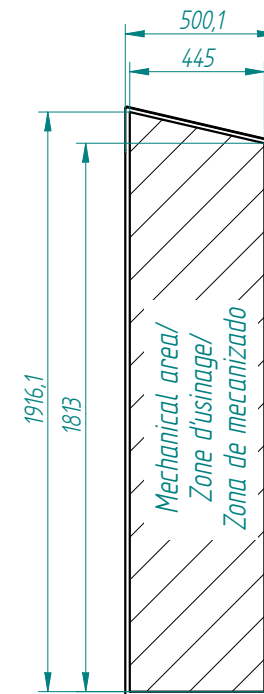
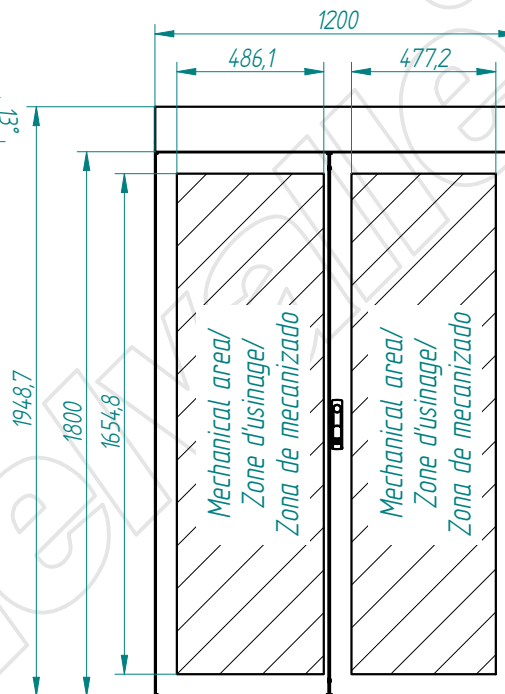
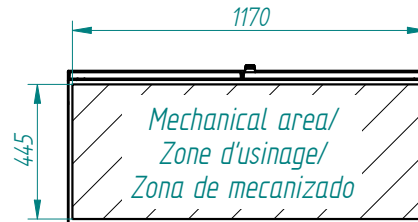
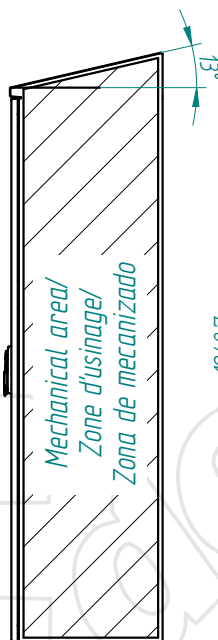
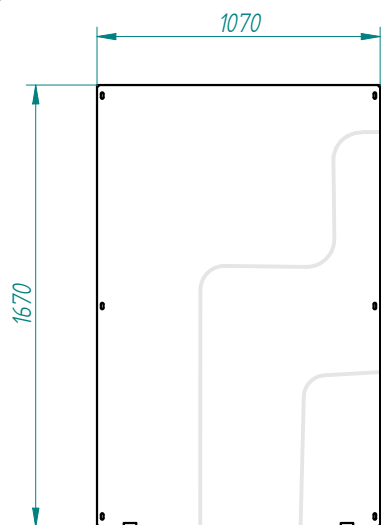
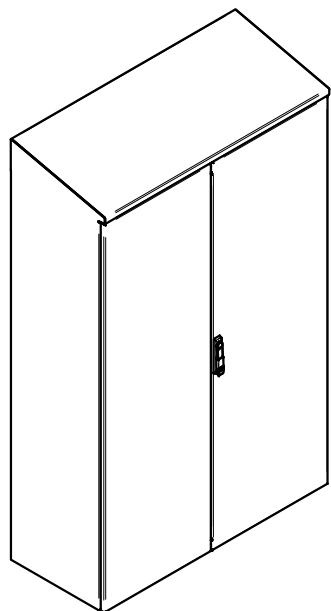

TOLERANCIA GENERAL
DE MECANIZACION
segun DIN 7168

| | | | |
|------------------------|------------|---------|-----------|
| Creación del documento | 05/09/2014 | D.MTNEZ | A |
| MODIFICACIONES | FECHA: | FIRMA: | REVISIÓN: |

Referencia:

| | | | |
|--------------|---|--------|------------|
| DIBUJADO: | 05/09/2014 | FIRMA: | D.Martinez |
| APROBADO: | 05/09/2014 | FIRMA: | D.Martinez |
| DESIGNACIÓN: | fresh tribeca 2p-1800x1200x500-estandar | | |

Nº PLANO:



This present document and its contents are confidential, and are the exclusive intellectual and / or industrial property of DEVALLE. In addition to any technology, design, invention, work, process, know-how, calculation, manual, method, solution, idea, improvement, drawing, diagram, modification, contribution and, in short, any associated information or documentation involving industrial or intellectual property developed or supplied by DEVALLE on the occasion of the quote, order execution or incorporated into the design or operation of the supply. The recipient may not use such property in his favour or in that of a third party for purposes other than the fulfilment of the order and the operation and maintenance of the supply, without the prior written consent of DEVALLE. It is strictly forbidden to totally or partially reproduce this document and to misuse it and / or to show it to third parties. The infringing parties shall be required to pay the corresponding compensation for damages, and any other legal or criminal responsibility is the infringement may give rise to.

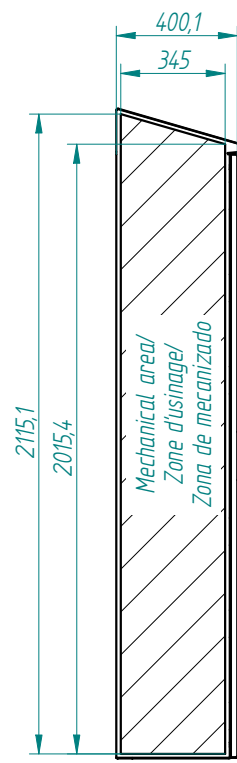
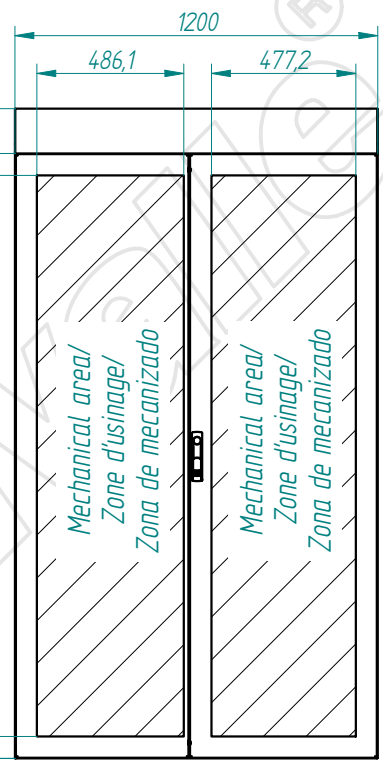
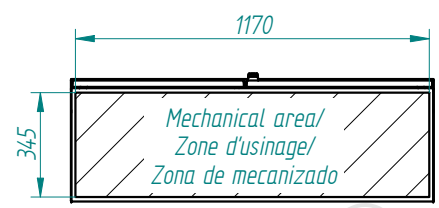
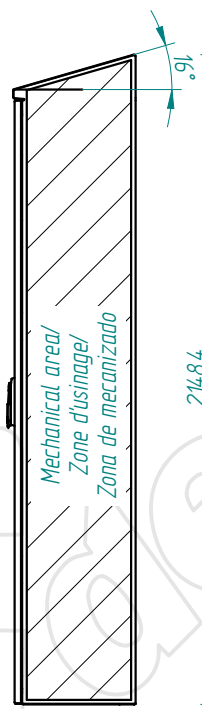
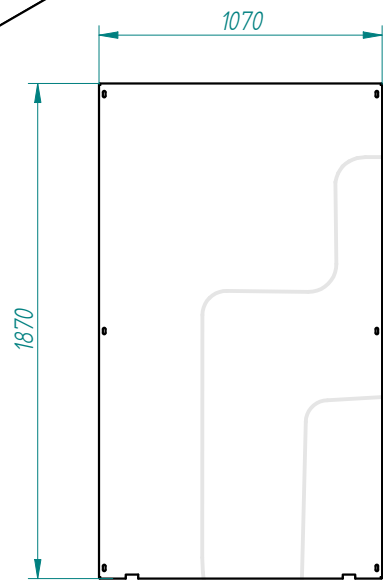
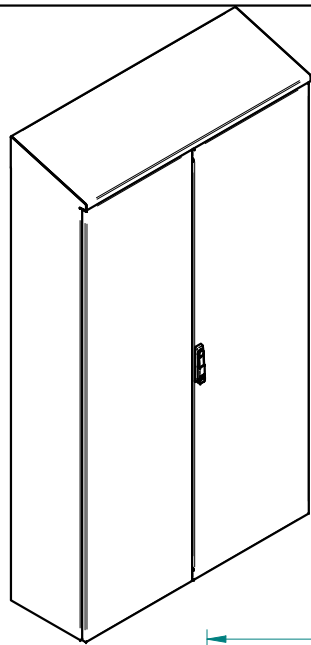

TOLERANCIA GENERAL DE MECANIZACION segun DIN 7168

| | | | |
|------------------------|------------|---------|-----------|
| Creación del documento | 05/09/2014 | D.MTNEZ | A |
| MODIFICACIONES | FECHA: | FIRMA: | REVISIÓN: |

Referencia:
- plegado:
- acabado:

| | | | |
|--------------|---|--------|------------|
| DIBUJADO: | 05/09/2014 | FIRMA: | D.Martinez |
| APROBADO: | 05/09/2014 | FIRMA: | D.Martinez |
| DESIGNACIÓN: | fresh tribeca 2p-2000x1200x400-estandar | | |

Nº PLANO: 



This present document and its contents are confidential, and are the exclusive intellectual and / or industrial property of DEVALLE. In addition to any technology, design, invention, work, process, know-how, calculation, manual, method, solution, idea, improvement, drawing, diagram, modification, contribution and, in short, any associated information or documentation involving industrial or intellectual property developed or supplied by DEVALLE on the occasion of the quote, order execution or incorporated into the design or operation of the supply. The recipient may not use such property in his favour or in that of a third party for purposes other than the fulfilment of the order and the operation and maintenance of the supply, without the prior written consent of DEVALLE. It is strictly forbidden to totally or partially reproduce this document and to misuse it and / or to show it to third parties. The infringing parties shall be required to pay the corresponding compensation for damages, and any other legal or criminal responsibility if the infringement may give rise to.

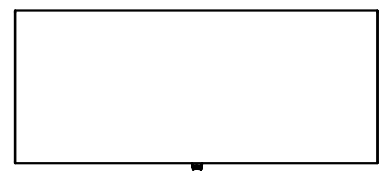
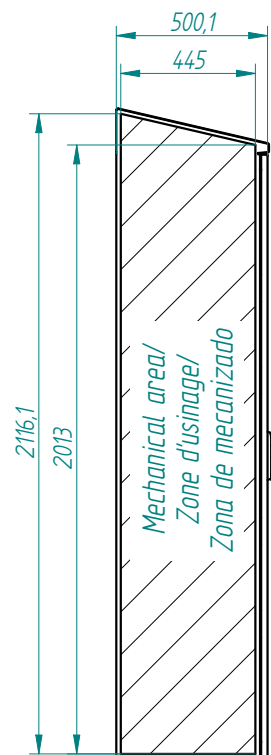
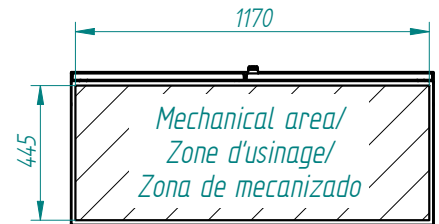
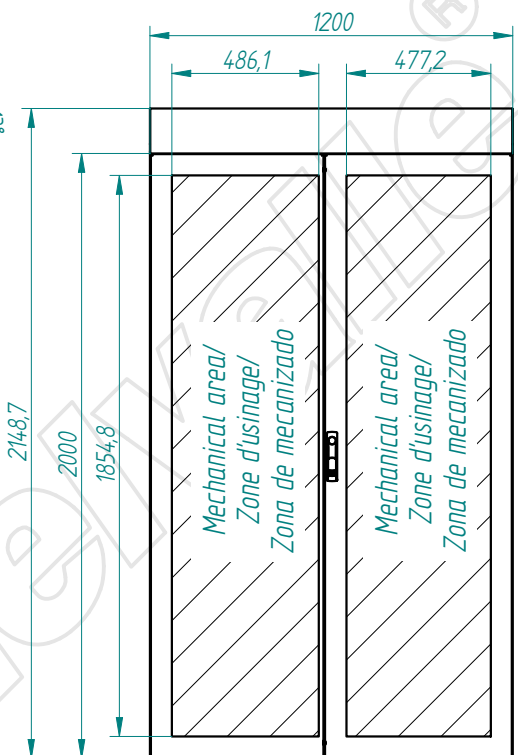
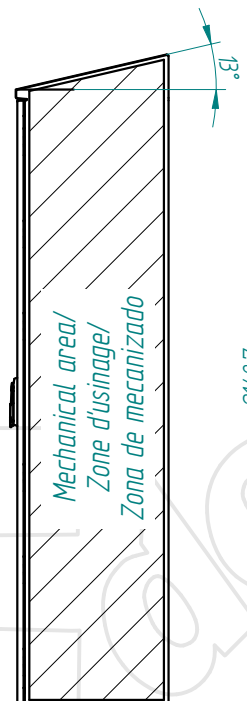
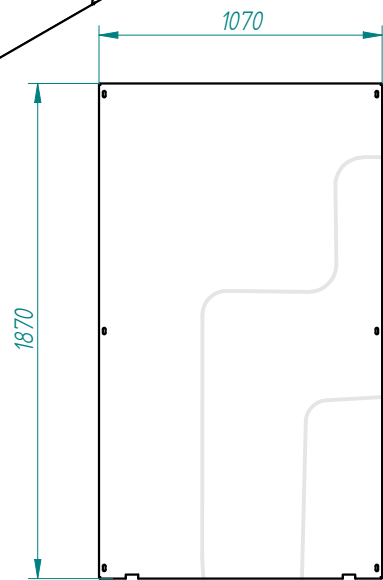
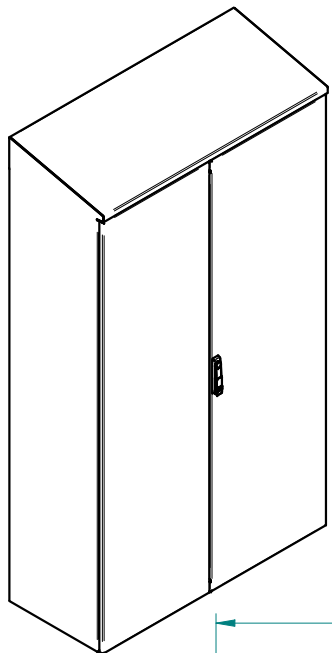

| | | | | | | | | | |
|---|------------------------|------------|---------|-----------|---------------------------------------|--------------|---|------------|------------|
| TOLERANCIA GENERAL DE MECANIZACION segun DIN 7168 | Creación del documento | 05/09/2014 | D.MTNEZ | A | Referencia: - plegado: acabado. | DIBUJADO: | 05/09/2014 | FIRMA: | D.Martinez |
| | MODIFICACIONES | FECHA: | FIRMA: | REVISIÓN: | | APROBADO: | 05/09/2014 | D.Martinez | |
| | | | | | | DESIGNACIÓN: | fresh tribeca 2p-2000x1200x500-estandar | | |
| | | | | | | Nº PLANO: | | | |



This present document and its contents are confidential, and are the exclusive intellectual and / or industrial property of DEVALLE. In addition to any technology, design, invention, work, process, know-how, calculation, manual, method, solution, idea, improvement, drawing, diagram, modification, contribution and, in short, any associated information or documentation involving industrial or intellectual property developed or supplied by DEVALLE on the occasion of the quote, order execution or incorporated into the design or operation of the supply. The recipient may not use such property in his favour or in that of a third party for purposes other than the fulfilment of the order and the operation and maintenance of the supply, without the prior written consent of DEVALLE. It is strictly forbidden to totally or partially reproduce this document and to misuse it and / or to show it to third parties. The infringing parties shall be required to pay the corresponding compensation for damages, and any other legal or criminal responsibility is the infringer may give rise to.

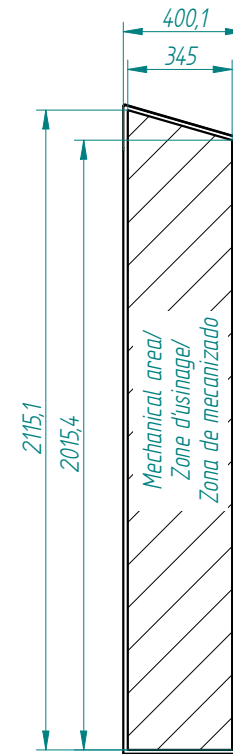
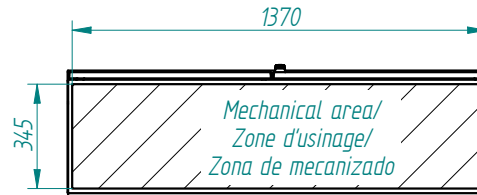
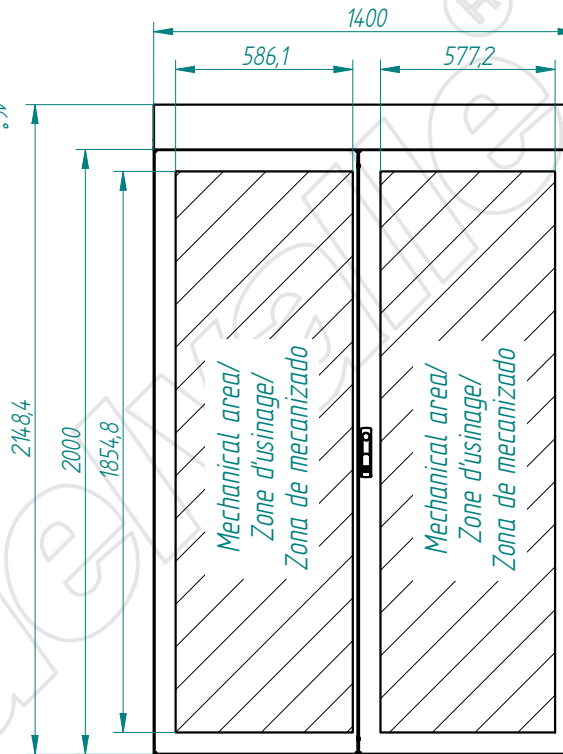
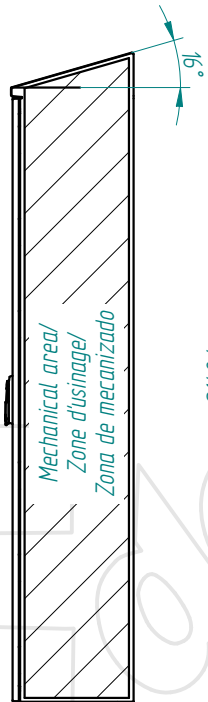
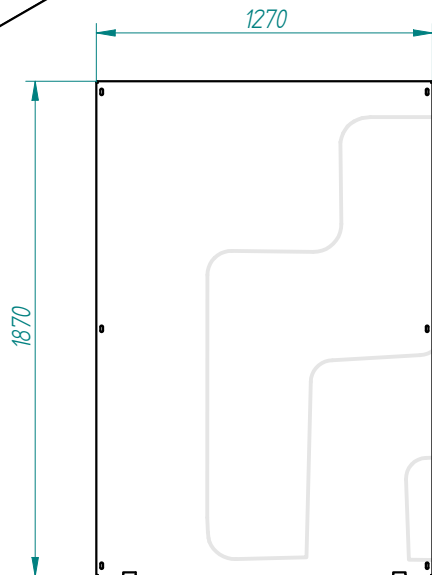
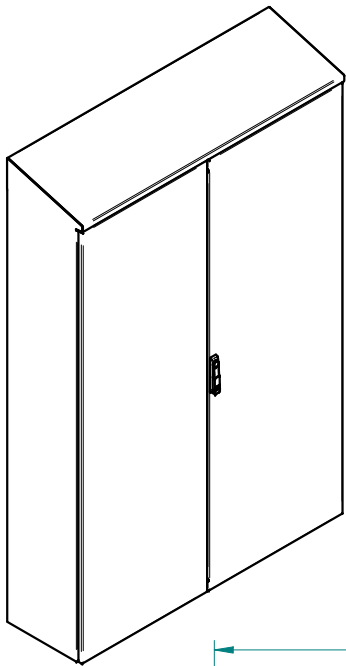

| | | | | | | | | |
|---|------------------------|------------|---------|-----------|----------------------|---|------------|------------|
| TOLERANCIA GENERAL DE MECANIZACION segun DIN 7168 | | | | | Referencia: | | FECHA: | FIRMA: |
| | | | | | | DIBUJADO: | 05/09/2014 | D.Martinez |
| | | | | | | APROBADO: | 05/09/2014 | D.Martinez |
| | Creación del documento | 05/09/2014 | D.MTNEZ | A | - | DESIGNACIÓN: | | Nº PLANO: |
| | MODIFICACIONES | FECHA: | FIRMA: | REVISIÓN: | plegado: acabado: | fresh tribeca 2p-2000x1400x400-estandar | | |



This present document and its contents are confidential, and are the exclusive intellectual and / or industrial property of DEVALLE. In addition to any technology, design, invention, work, process, know-how, calculation, manual, method, solution, idea, improvement, drawing, diagram, modification, contribution and, in short, any associated information or documentation involving industrial or intellectual property developed or supplied by DEVALLE on the occasion of the quote, order execution or incorporated into the design or operation of the supply. The recipient may not use such property in his favour or in that of a third party for purposes other than the fulfilment of the order and the operation and maintenance of the supply, without the prior written consent of DEVALLE. It is strictly forbidden to totally or partially reproduce this document and to misuse it and / or to show it to third parties. The infringing parties shall be required to pay the corresponding compensation for damages, and any other legal or criminal responsibility is the infringer's sole responsibility.

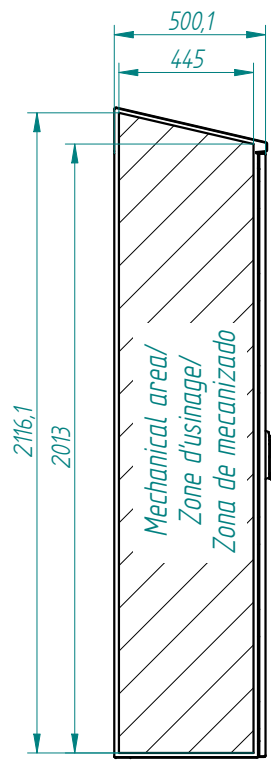
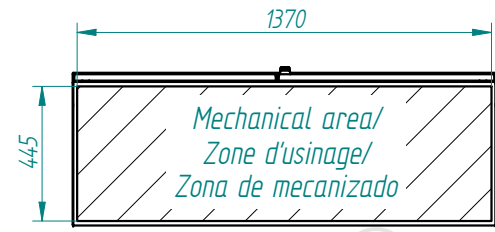
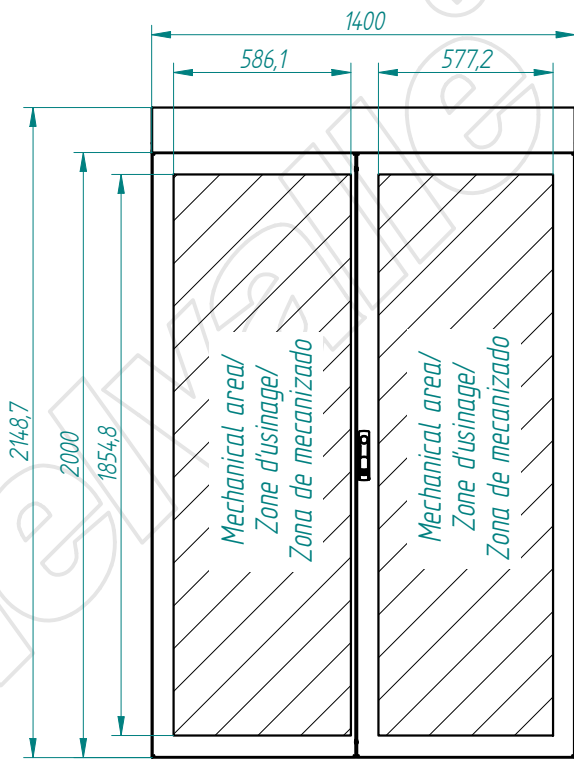
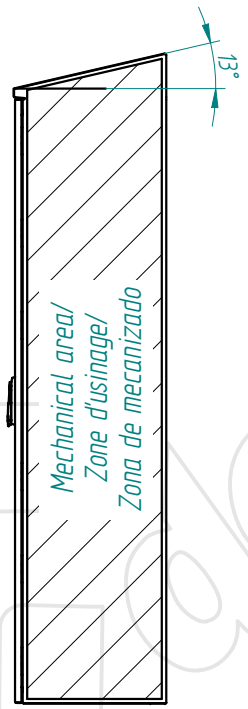
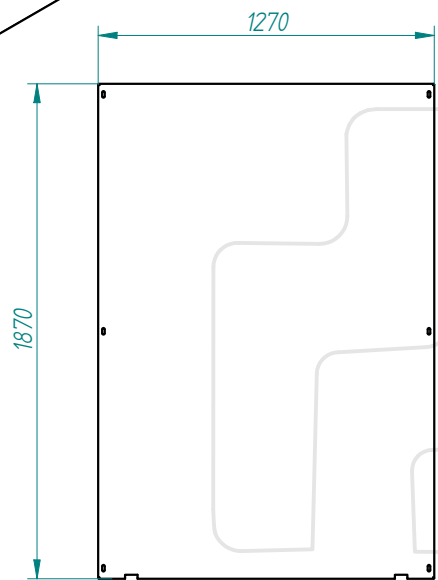
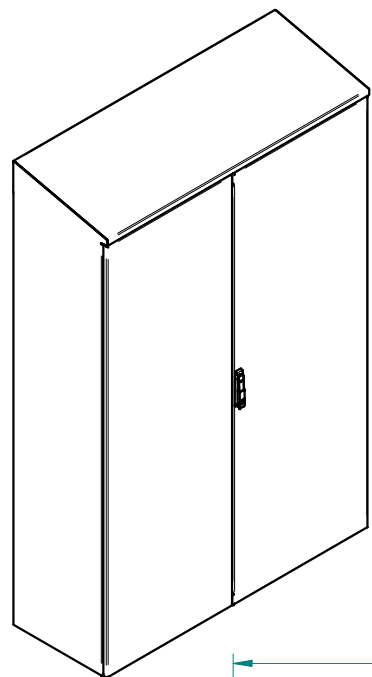

| | | | | | | | | | |
|---|------------------------|------------|---------|-----------|---|--------------|---|--------|------------|
| TOLERANCIA GENERAL DE MECANIZACION según DIN 7168 | | | | | Referencia: - plegado: - acabado: | DIBUJADO: | 05/09/2014 | FIRMA: | D.Martínez |
| | | | | | | APROBADO: | 05/09/2014 | FIRMA: | D.Martínez |
| | Creación del documento | 05/09/2014 | D.MTNEZ | A | | DESIGNACIÓN: | fresh tribeca 2p-2000x1400x500-estandar | | |
| | MODIFICACIONES | FECHA: | FIRMA: | REVISIÓN: | | Nº PLANO: | | | |



This present document and its contents are confidential, and are the exclusive intellectual and / or industrial property of DELVALLE. In addition to any technology, design, invention, work, process, know-how, calculation, manual, method, solution, idea, improvement, drawing, diagram, modification, contribution and, in short, any associated information or documentation involving industrial or intellectual property developed or supplied by DELVALLE on the occasion of the quote, order execution or incorporated into the design or operation of the supply. The recipient may not use such property in his favour or in that of a third party for purposes other than the fulfilment of the order and the operation and maintenance of the supply, without the prior written consent of DELVALLE. It is strictly forbidden to totally or partially reproduce this document and to misuse it and / or to show it to third parties. The infringing parties shall be required to pay the corresponding compensation for damages, and any other legal or criminal responsibility is the infringement may give rise to.

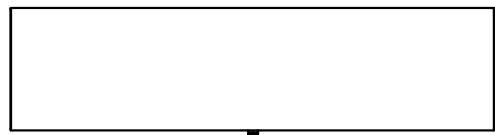
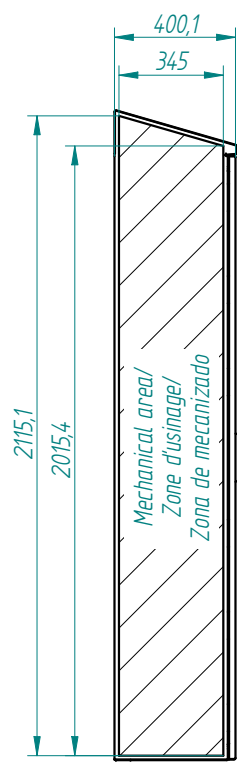
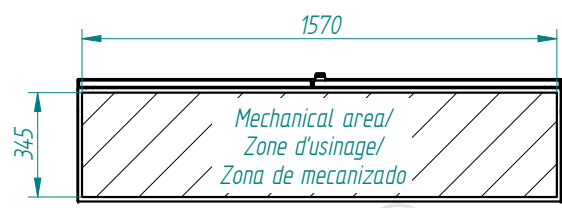
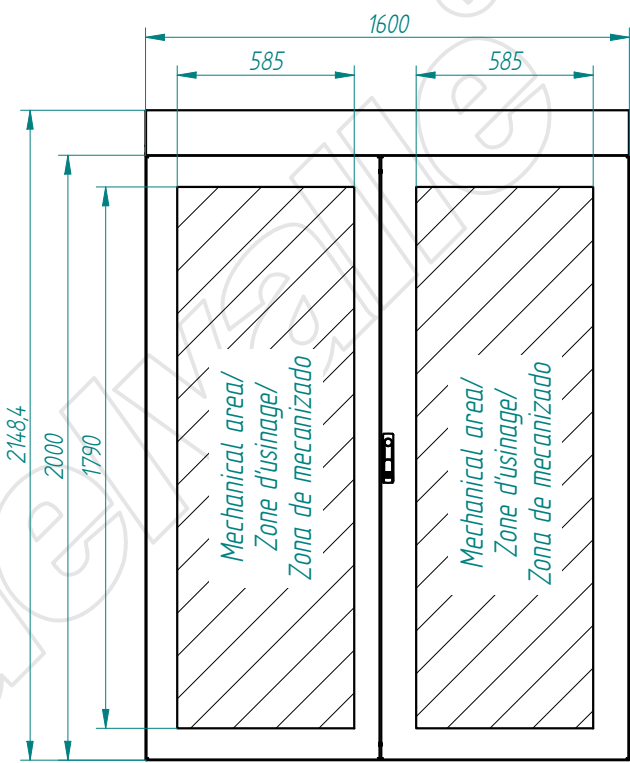
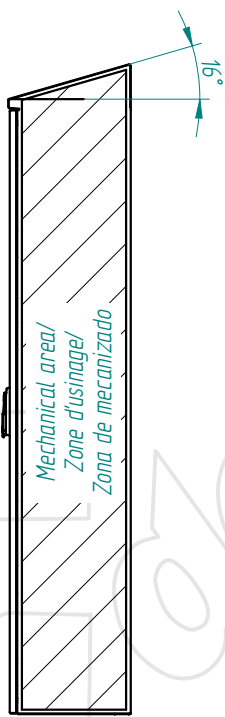
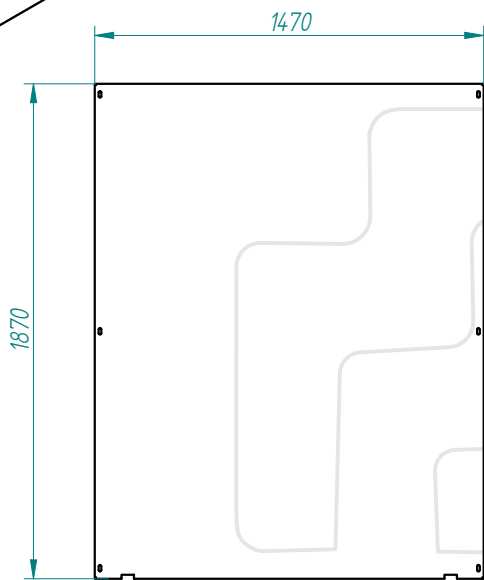
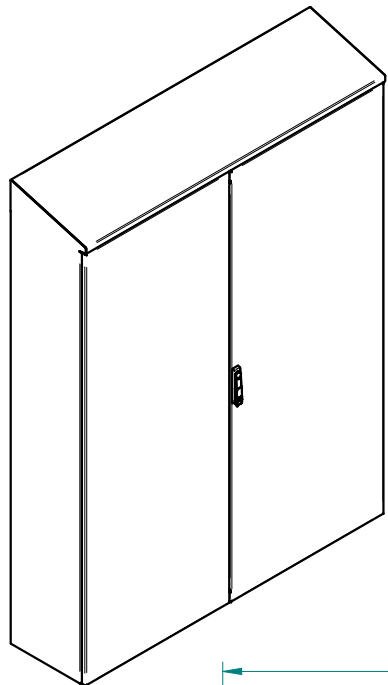

| | | | | | | | | | |
|---|------------------------|------------|---------|-----------|----------------------|---|------------|------------|---|
| TOLERANCIA GENERAL DE MECANIZACION segun DIN 7168 | | | | | Referencia: | | FECHA: | FIRMA: |  |
| | | | | | | DIBUJADO: | 05/09/2014 | D.Martinez | |
| | | | | | | APROBADO: | 05/09/2014 | D.Martinez | |
| | Creación del documento | 05/09/2014 | D.MTNEZ | A | - | DESIGNACIÓN: | | Nº PLANO: | |
| | MODIFICACIONES | FECHA: | FIRMA: | REVISIÓN: | plegado: acabado: | fresh tribeca 2p-2000x1600x400-estandar | | | |

This present document and its contents are confidential, and are the exclusive intellectual and / or industrial property of DEVALLE. In addition to any technology, design, invention, work, process, know-how, calculation, manual, method, solution, idea, improvement, drawing, diagram, modification, contribution and, in short, any associated information or documentation involving industrial or intellectual property developed or supplied by DEVALLE on the occasion of the quote, order execution or incorporated into the design or operation of the supply. The recipient may not use such property in his favour or in that of a third party for purposes other than the fulfilment of the order and the operation and maintenance of the supply, without the prior written consent of DEVALLE. It is strictly forbidden to totally or partially reproduce this document and to misuse it and / or to show it to third parties. The infringing parties shall be required to pay the corresponding compensation for damages, and any other legal or criminal responsibility is the infringement may give rise to.

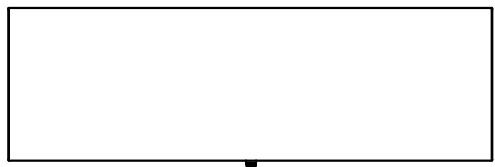
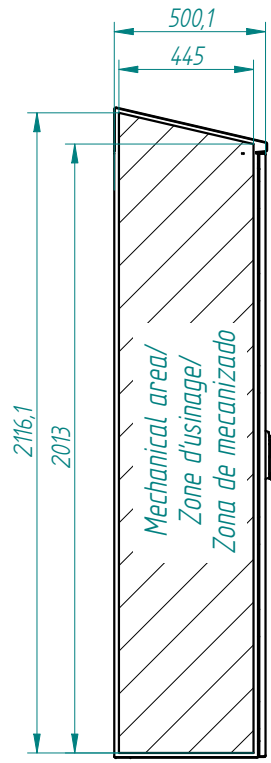
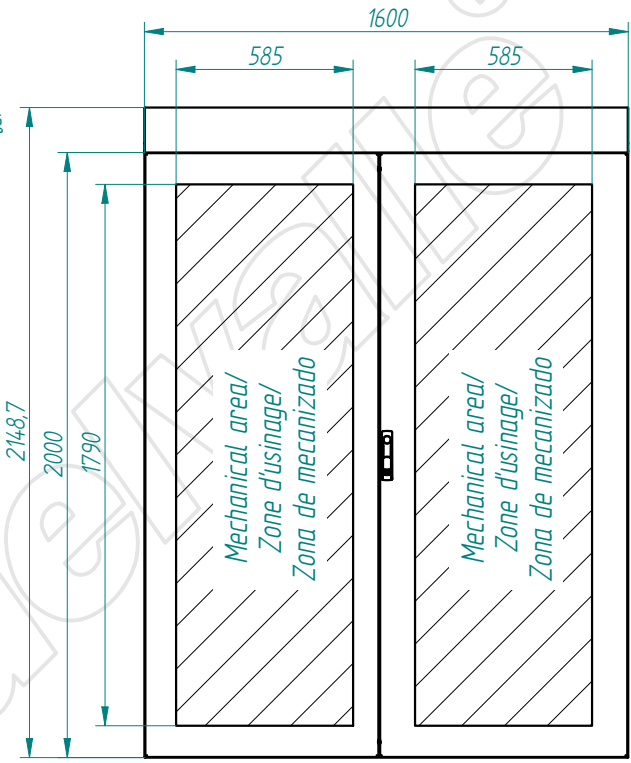
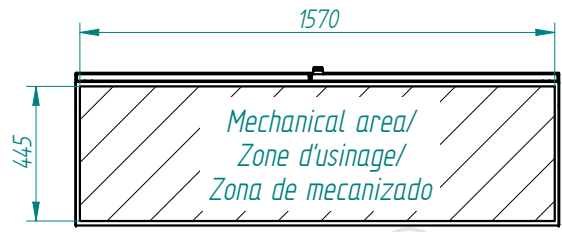
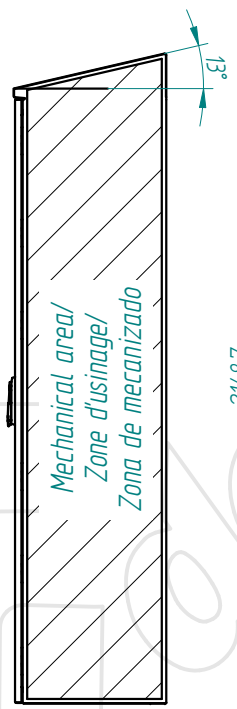
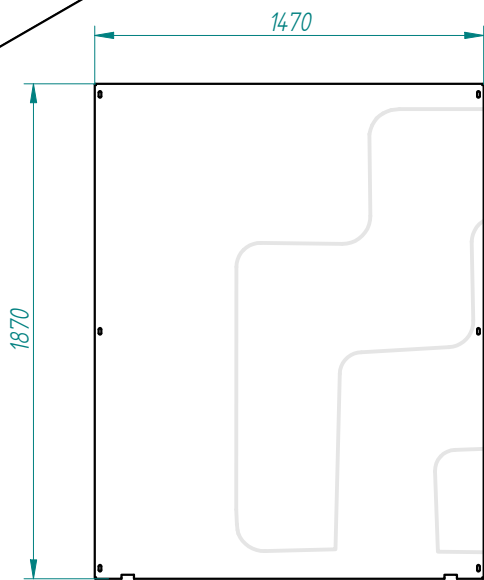
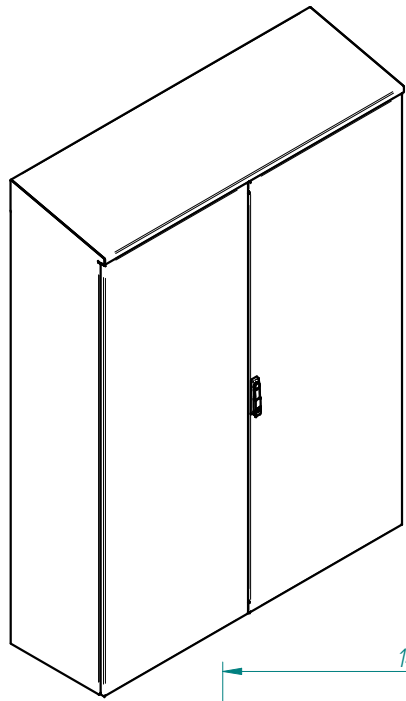

| | | | | |
|---|------------------------|------------|---------|-----------|
| TOLERANCIA GENERAL DE MECANIZACION según DIN 7168 | Creación del documento | 05/09/2014 | D.MTNEZ | A |
| | MODIFICACIONES | FECHA: | FIRMA: | REVISIÓN: |

| | | | | |
|---|-----------|------------|------------|------------|
| Referencia: | DIBUJADO: | 05/09/2014 | FIRMA: | D.Martínez |
| | APROBADO: | 05/09/2014 | D.Martínez | |
| DESIGNACIÓN: | | | | Nº PLANO: |
| fresh tribeca 2p-2000x1600x500-estandar | | | | |



Nº PLANO:

