

# FILTER FANS PRIUS SERIES IP54 IP55





## WE PUT AT YOUR DISPOSAL

We offer over **50 years** providing solutions to demanding customers who require very specific characteristics and behaviour according to the sector and their needs.

## WHEREVER YOU GO

We are committed to working closely with our customers, providing them with **exceptional service** and offering an advanced and extensive range of products with very competitive prices.

## HIGH STANDARD OF QUALITY AND SERVICES

We only use materials provided by companies who offer the very **highest quality**, suitable and certified products. Our success is due to top quality assurance: ISO 9001, SGS, UL, TÜV, ISO 14000 and Ohsas 18001.

## CUSTOMIZE TOTALLY YOUR ENCLOSURE

Our production systems can give custom-made solutions **on demand**. Every colour from RAL chart is available to be personalized. A variety of protection standards thanks to our own painting facilities.



**100%**  
Diseñado y fabricado íntegramente en España  
*Entirely designed and manufactures in Spain*

## CONTACT US

Confidentiality, reliability & quality

[www.delvallebox.com](http://www.delvallebox.com)

[comercial@delvalle.es](mailto:comercial@delvalle.es)

+34 945 601 381

ALSO ONLINE

Please contact our technical sales department

A team of professionals with high experience and ability to solve all your queries



# FILTER FANS PRIUS SERIES IP54 IP55



Examples



Examples stainless steel version

## Maximum Reliable and Efficient

Built-in filter fan, high performance, low power, and soundless, with slim design, only 4 mm, and affordable price.

These fans are ideal for the removal of large heat loads inside the cabinets in an economical and easy way.

Its compact design, easy mounting and disassembly for quick cleaning make it ideal for use in any heat dissipation inside the enclosure. Quick assembly thanks to the mounting fast "Clip-on" with self-adhesive gasket.

➔ [FOR MORE INFORMATION CLICK HERE](#)

## APPLICATIONS

Specially designed for use in installations that need a high level of protection IP54/55.



## CHARACTERISTICS

- Life time +50.000 hours in 40°C.
- ECO friendly: low consumption, high efficiency and very silent.
- Mounting fast "Clip-on".
- Self-adhesive gasket.
- Air flow direction "inside-out".
- Ball bearing.
- Panels with thickness in range 1.2 - 2.4 mm.
- Operating temperature -10 /+70°C.
- Duty cycle 100%.
- The fan is supplied with filter designed with easy cleaning and high resistance.
- Also in stainless steel version.

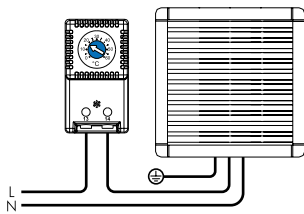

Example thermostat



Example filtering with case IP55

## OPTIONS

- We recommend install our thermostats.
- EMC Electromagnetic Compatible Version.
- Flow direction "outside-in"
- UL approved (Underwriters laboratories). File N° E301228
- RAL 7032 (grey) and RAL 9005 (black).
- Version with IP55 casing in AISI 304 or AISI 316 stainless steel.

## STAINLESS STEEL FILTER FANS

All fan models can be supplied in stainless steel, simply add the letter "X" to your reference  
Ex. MVP024ASX (les mesures de la grille augmente de 2 mm).

The fan Prius inox is slim, easy clip mounting by clip, with IP55 protection and ball bearing. Made of ABS with stainless steel casing and slim design, very functional and innovative.

Specially designed to place in our stainless steel cabinets and outdoor cabinets.



# FILTER FANS PRIUS SERIES

IP54

IP55

## COOLING PERFORMANCE DIAGRAM

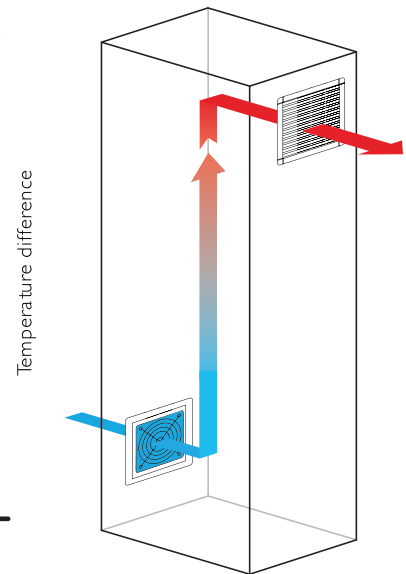
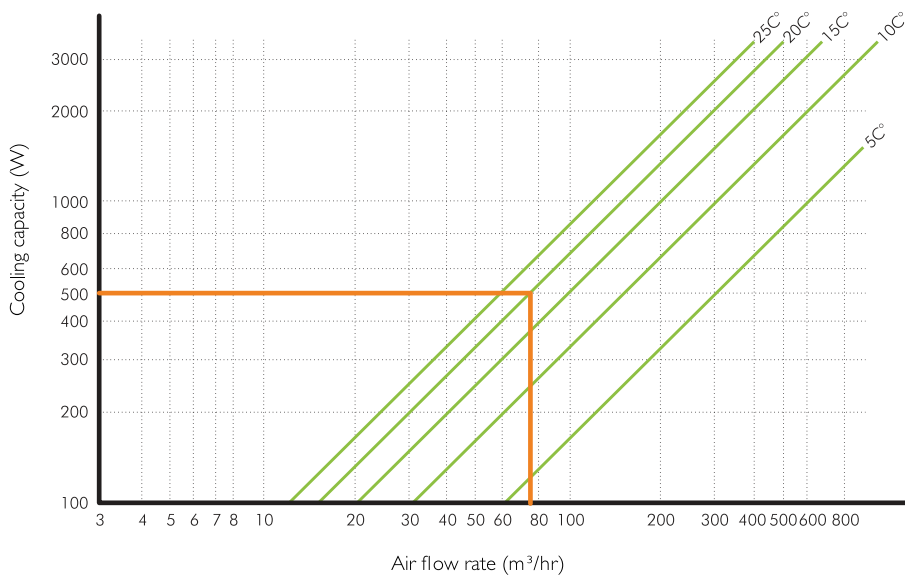

## NORMATIVE

- IP54/Class I Norm IEC 60529.
- Built under directive 2014/35/UE low voltage.
- Operating temperature -10°C +70°C.
- Filter mat (Eurovent) EU2 and EU3 (depending on model)
- Certificate UL, Nema 12.

## FILTERS (ACCESORY)



This standard filter mat for fans are supplied in packs of 10.

To maintain high performance, it is necessary to periodically review the level of clogging of the filter and replace it if necessary.

These filters are made of synthetic self-extinguishing fiber with progressive filtration capacity.

REF: MVPF024 (for fan MVP024)

REF: MVPF055 (for fan MVP055)

REF: MVPF120 (for fan MVP120)

REF: MVPF230 (for fan MVP230)

REF: MVPF500 (for fan MVP500)

# FILTER FANS PRIUS SERIES IP54 IP55

MODEL MVP024 (air flow 24m<sup>3</sup>/h) IP54



GRILL

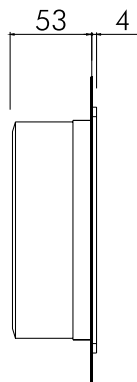
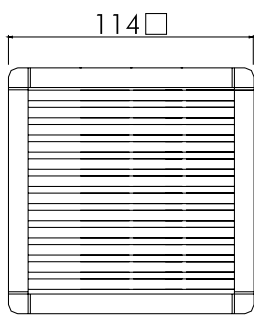

MVP024AS | MVP024BS

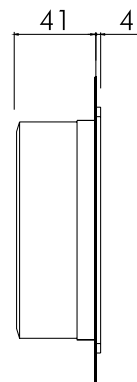

MVP024DS | MVP024ES

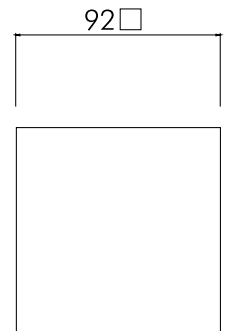

## REFERENCE - FILTER FAN MVP024

REFERENCE	AIR FLOW RATE	POWER SUPPLY	POWER CONSUMPTION	CURRENT CONSUMPTION	OVERCURRENT PROTECTION	ELECTRIC CONNECTION	NOISE	FILTER MAT (EUROVENT)	MACHINING MOUNTING
MVP024AS	24m <sup>3</sup> /h	230V/50-60Hz	13W	0,10A	Impedance	faston 2,8x0,5mm	30dB	EU2	92x92 $^{+0,5}_0$
MVP024BS		115V/50-60Hz		0,14A					
MVP024DS		12VCD	3W	0,25A		2-pole terminal 1,5mm <sup>2</sup>	35dB		
MVP024ES		24VCD	4W	0,16A					
Option flow direction "outdoor-in"		Delete "S" to the reference. Ex: "MVP024A"							
Option UL approval		Add "UL" to the reference. Ex: "MVP024ASUL"							
Version EMC		Add "M" to the reference. Ex: "MVP024ASM"							
Version stainless steel		Add "X" to the reference. Ex: "MVP024ASX"							
Versión IP55 (case)		Add to the reference MVP024CUBX (AISI 304) or MVP024CUBX6 (AISI 316)							

## GRILL WITH FILTER

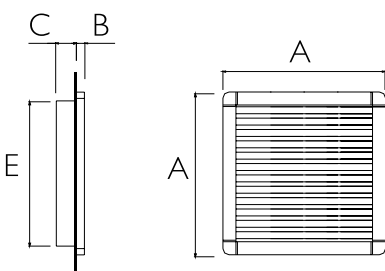

REFERENCE	MACHINING MOUNTING	DIMENSIONS (mm)			
		A	B	C	E
MVPR024	92x92 $^{+0,5}_0$	114	4	12	90
Version Norms UL		Add "UL" to the reference			
Version EMC		Add "M" to the reference			
Version stainless steel		Add "X" to the reference			

# FILTER FANS PRIUS SERIES IP54 IP55

MODEL MVP055 (air flow 55m<sup>3</sup>/h) IP54



GRILL

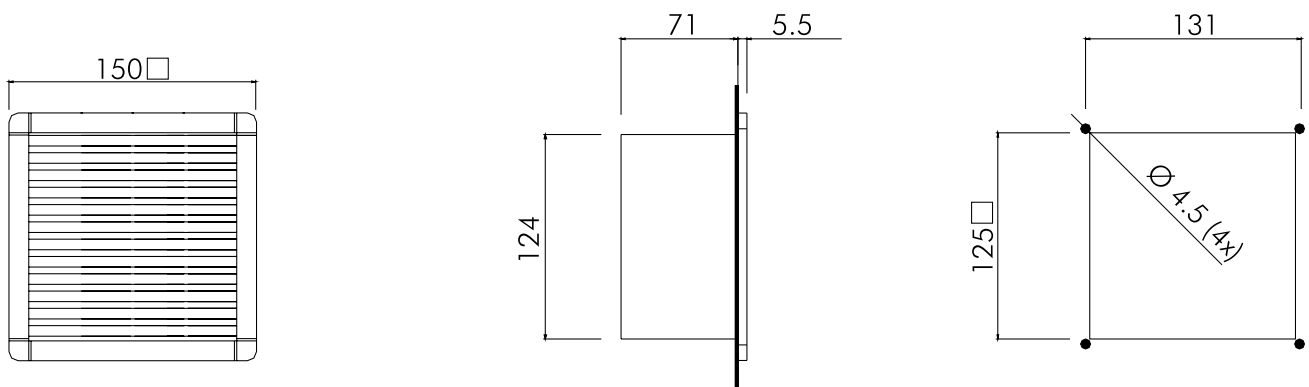

REFERENCE - FILTER FAN MVP055

REFERENCE	AIR FLOW RATE	POWER SUPPLY	POWER CONSUMPTION	CURRENT CONSUMPTION	OVERCURRENT PROTECTION	ELECTRIC CONNECTION	NOISE	FILTER MAT (EUROVENT)	MACHINING MOUNTING
MVP055AS	55m <sup>3</sup> /h	230V/50-60Hz	22W	0,14A	Impedance	faston 2,8x0,5mm	43dB	EU3	125x125 <sup>+1</sup> / <sub>-1</sub>
MVP055BS		115V/50-60Hz		0,26A					
MVP055ES		24VCD	9W	0,37A		2-pole terminal 1,5mm <sup>2</sup>	45dB		
MVP055FS		48VCD	13W	0,27A					
Option flow direction "outdoor-in"		Delete "S" to the reference. Ex: "MVP055A"							
Option UL approval		Add "UL" to the reference. Ex: "MVP055ASUL"							
Version EMC		Add "M" to the reference. Ex: "MVP055ASM"							
Version stainless steel		Add "X" to the reference. Ex: "MVP055ASX"							
Versión IP55 (case)		Add to the reference MVP055CUBX (AISI 304) or MVP055CUBX6 (AISI 316)							

## GRILL WITH FILTER

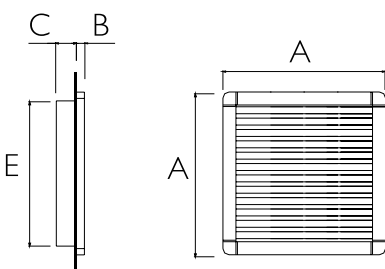

REFERENCE	DIMENSIONS (mm)				
REFERENCE	MACHINING MOUNTING	A	B	C	E
MVPR055	125x125 <sup>+1</sup> / <sub>-1</sub>	150	5,5	22	124
Version Norms UL	Add "UL" to the reference				
Version EMC	Add "M" to the reference				
Version stainless steel	Add "X" to the reference				

# FILTER FANS PRIUS SERIES IP54 IP55

## MODEL MVPI20 (air flow 120m<sup>3</sup>/h) IP54



GRILL

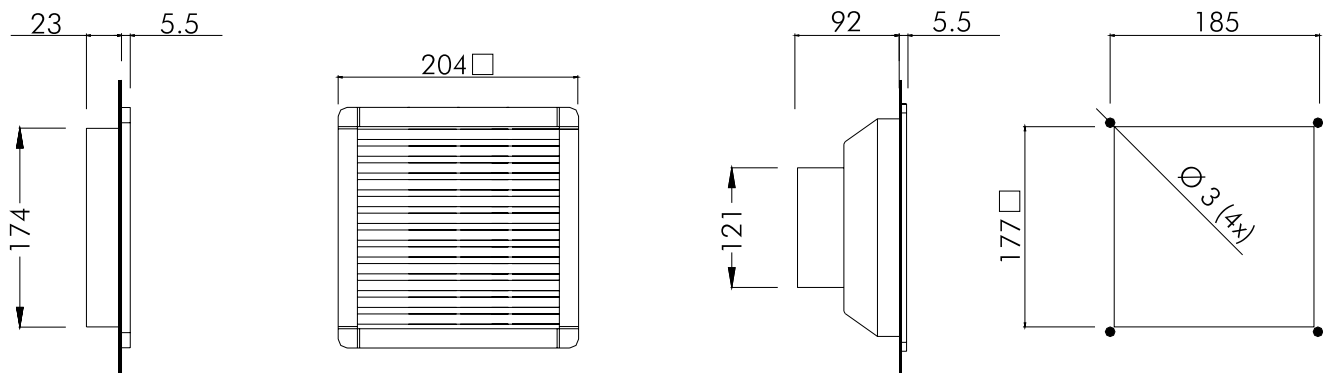

REFERENCE - FILTER FAN MVPI20

REFERENCE	AIR FLOW RATE	POWER SUPPLY	POWER CONSUMPTION	CURRENT CONSUMPTION	OVERCURRENT PROTECTION	ELECTRIC CONNECTION	NOISE	FILTER MAT (EUROVENT)	MACHINING MOUNTING
MVPI20AS	120m <sup>3</sup> /h	230V/50-60Hz	22W	0,14A	Impedance	faston 2,8x0,5mm	43dB	EU3	177x177 <sup>+1</sup> / <sub>0</sub>
MVPI20BS		115V/50-60Hz		0,26A					
MVPI20ES		24VCD	9W	0,37A		2-pole terminal 1,5mm <sup>2</sup>	45dB		
MVPI20FS		48VCD	13W	0,27A					
Option flow direction "outdoor-in"		Delete "S" to the reference. Ex: "MVPI20A"							
Option UL approval		Add "UL" to the reference. Ex: "MVPI20ASUL"							
Version EMC		Add "M" to the reference. Ex: "MVPI20ASM"							
Version stainless steel		Add "X" to the reference. Ex: "MVPI20ASX"							
Versión IP55 (case)		Add to the reference MVPI20CUBX (AISI 304) or MVPI20CUBX6 (AISI 316)							

## GRILL WITH FILTER

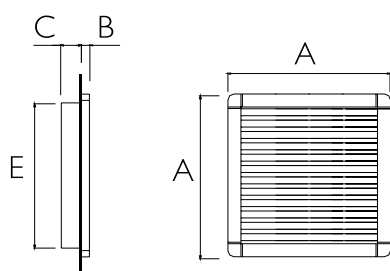

REFERENCE	DIMENSIONS (mm)				
REFERENCE	MACHINING MOUNTING	A	B	C	E
MVPI20	177x177 <sup>+1</sup> / <sub>0</sub>	204	5,5	23	174
Version Norms UL		Add "UL" to the reference			
Version EMC		Add "M" to the reference			
Version stainless steel		Add "X" to the reference			

# FILTER FANS PRIUS SERIES IP54 IP55

MODEL MVP230 | MVP370 (air flow 230m<sup>3</sup>/h | 370m<sup>3</sup>/h) IP54



GRILL

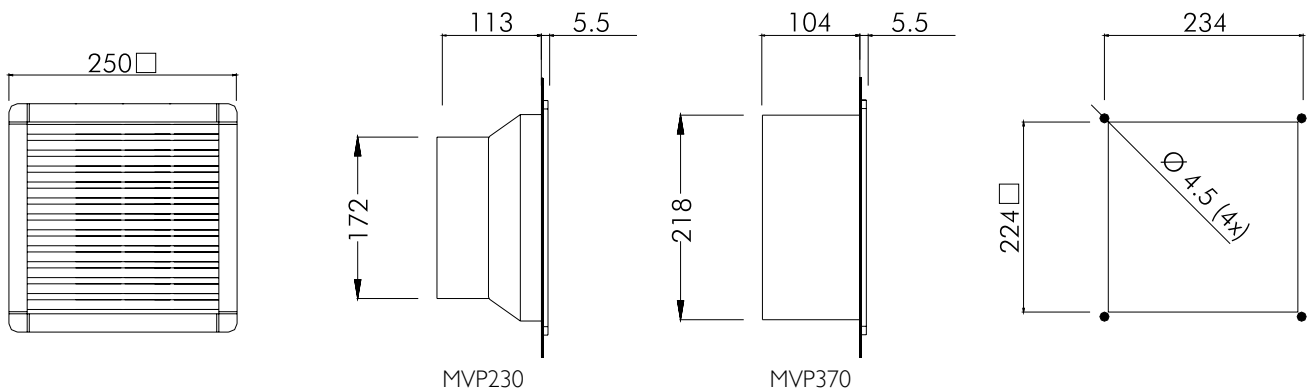

## REFERENCE - FILTER FAN MVP230 | MVP370

REFERENCE	AIR FLOW RATE	POWER SUPPLY	POWER CONSUMPTION	CURRENT CONSUMPTION	OVERCURRENT PROTECTION	ELECTRIC CONNECTION	NOISE	FILTER MAT (EUROVENT)	MACHINING MOUNTING
MVP230AS	230m <sup>3</sup> /h	230V/50-60Hz	40W	0,17A	Thermal	3-pole terminal 2,5mm <sup>2</sup>	53dB	EU3	224x224 <sup>+1</sup> / <sub>0</sub>
MVP230BS		115V/50-60Hz		0,34A					
MVP230ES		24VCD	1,08A	Impedance	61dB				
MVP230FS		48VCD	0,68A						
MVP370AS	370m <sup>3</sup> /h	230V/50-60Hz	70W	0,40A	Thermal	4-pole terminal 1,5mm <sup>2</sup>	65dB		
MVP370BS		115V/50-60Hz		0,80A					
MVP370CS		400V/50-60Hz	0,18A						
Option flow direction "outdoor-in"	Delete "S" to the reference. Ex: "MVP230A"								
Option UL approval	Add "UL" to the reference. Ex: "MVP230ASUL"								
Version EMC	Add "M" to the reference. Ex: "MVP230ASM"								
Version stainless steel	Add "X" to the reference. Ex: "MVP230ASX"								
Versión IP55 (case)	Add to the reference MVP230CUBX (AISI 304) or MVP230CUBX6 (AISI 316)								

## GRILL WITH FILTER

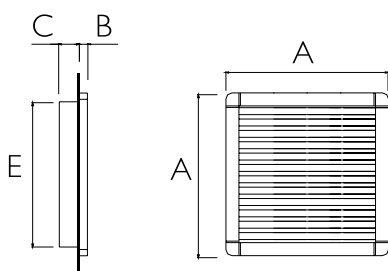

REFERENCE	DIMENSIONS (mm)				
REFERENCE	MACHINING MOUNTING	A	B	C	E
MVPR230	224x224 <sup>+1</sup> / <sub>0</sub>	250	5,5	24	220
Version Norms UL	Add "UL" to the reference				
Version EMC	Add "M" to the reference				
Version stainless steel	Add "X" to the reference				

# FILTER FANS PRIUS SERIES IP54 IP55

MODEL MVP500 | MVP630 (air flow 500m<sup>3</sup>/h | 630m<sup>3</sup>/h) IP54



GRILL

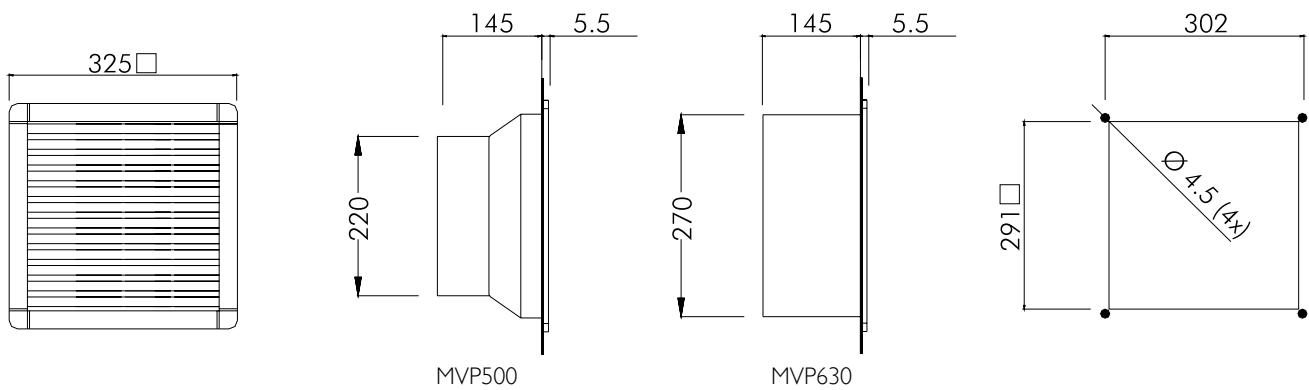

REFERENCE - FILTER FAN MVP500 | MVP630

REFERENCE	AIR FLOW RATE	POWER SUPPLY	POWER CONSUMPTION	CURRENT CONSUMPTION	OVERCURRENT PROTECTION	ELECTRIC CONNECTION	NOISE	FILTER MAT (EUROVENT)	MACHINING MOUNTING
MVP500AS	500m <sup>3</sup> /h	230V/50-60Hz	70W	0,40A	Thermal	3-pole terminal 2,5mm <sup>2</sup>	65dB	EU3	291x291 <sup>+1</sup> / <sub>0</sub>
MVP500BS		115V/50-60Hz		0,80A					
MVP500CS		400V/50-60Hz	60W	0,18A					
MVP630AS	630m <sup>3</sup> /h	230V/50-60Hz	130W	0,55A		4-pole terminal 1,5mm <sup>2</sup>	72dB		
MVP630BS		115V/50-60Hz		1,10A					
Option flow direction "outdoor-in"		Delete "S" to the reference. Ex: "MVP500A"							
Option UL approval		Add "UL" to the reference. Ex: "MVP500ASUL"							
Version EMC		Add "M" to the reference. Ex: "MVP500ASM"							
Version stainless steel		Add "X" to the reference. Ex: "MVP500ASX"							
Versión IP55 (case)		Add to the reference MVP500CUBX (AISI 304) or MVP500CUBX6 (AISI 316)							

## GRILL WITH FILTER

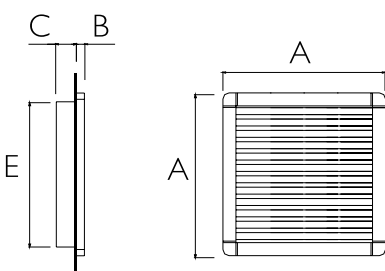

REFERENCE	DIMENSIONS (mm)				
REFERENCE	MACHINING MOUNTING	A	B	C	E
MVPR500	291x291 <sup>-1</sup> / <sub>0</sub>	320	5,5	24	290
Version Norms UL	Add "UL" to the reference				
Version EMC	Add "M" to the reference				
Version stainless steel	Add "X" to the reference				

# FILTER FANS PRIUS SERIES

IP54

IP55

OTHER ELEMENTS OF VENTILATION AND CLIMATE CONTROL

## ROOF FAN. VIPER SERIES

Roof Fan, specially designed for extracting heat from the top of the cabinet, so achieving a perfect air flow inside. Easy to install, provides protection from IP44 to IP54 depending on the model.

Air flow range from 600m<sup>3</sup> to 1.500m<sup>3</sup> per hour, with a silent working, waterproof and dust proof by sealed gasket.

Performance and durability, to get a clean air inside cabinets

Especially designed for use in the top of our cabinets for a perfect cooling of electrical and electronic equipments.



Contact us for more information.

## AIR CONDITIONING FOR ELECTRICAL BOXES

Indoor and outdoor solutions.

A solution when you need to cool your equipment due to the external conditions.

We have a wide range of IP54 cooling systems and heat exchangers for our cabinets.

Voltages between 350W and 10000W.

Contact us for more information.



## THERMOSTATS

Thermostats for small size electrical cabinets and boxes, dual for heat, for cold, etc..

Easy to install, reliable, economical and accurate, adaptable to every fan or thermostat in our series.

REF: MVKT001 I 40 (BLUE)

REF: MVKT001 I 41 (RED)

REF: MVKT001 I 42 (DUAL)



Contact us for more information.

# FILTER FANS PRIUS SERIES IP54 IP55

OTHER ELEMENTS OF VENTILATION AND CLIMATE CONTROL

## HIGROSTATS

Electro mechanical humidistat automatically controls moisture inside electrical boxes, and sends a signal to the fan or to the heater, depending on what is needed at all times, to prevent condensation inside the electrical panel.

REF: MVKT001 I 43A (DUAL 230V)  
REF: MVKT001 I 43B (DUAL 120V)

Contact us for more information.



## ENCLOSURE HEATERS

These heaters reduce temperature variation and avoid water condensation which may cause malfunction and corrosion of cabinets and boxes.

Heaters include PTC heating components. They are self-regulating, UL certified and available up to 1000 W. Their thermal output varies according to voltage.

You will get optimal heat dissipation thanks to small profiled aluminium cases covering our heaters.

They are used in traffic control systems, labeling machines, crane systems, telecommunications systems, as well as machines for food industry.

Resistances up to 750W with fans.

Contact us for more information.



**DELVALLE, EXPERTS IN VENTILATION AND CLIMATE CONTROL**

ONE SOLUTION FOR EVERY NEED. OUR ENGINEERS EQUIPMENT WILL FIND THE BEST CLIMATE CONTROL INSTALLATION AND GET A BETTER PERFORMANCE AND GREATER ENERGY AND COST SAVINGS.

## CUSTOMIZED ENCLOSURE SOLUTIONS DELVALLE

*Delvalle has more than 50 years of experience using the latest technology to implement and obtain the most innovative products on offer to all our customers. Delvalle is an ideal partner, combining an advanced and wide range of products at very competitive prices.*

*The customized manufacture of all electrical enclosures and cabinets Delvallebox is carry out with the most advanced technical methods and with the precision and consciousness of a craftsman. This makes the difference from competitors and is the best way to gain our customers' trust.*

*In Delvallebox we bear in mind that customers perceive the quality very clearly. In every product (for instance, in the cabinets here presented) safety and useful solutions are what customers value most.*



STAINLESS STEEL  
INDUSTRIAL ENCLOSURES



OUTDOOR ELECTRICAL  
ENCLOSURES



GLOBAL ELECTRICAL  
SOLUTIONS FOR URBAN AREAS



GALVANIZED STEEL  
ELECTRICAL ENCLOSURES

## ATEX INDUSTRIAL ENCLOSURES

SLOPED ROOF  
ENCLOSURES - HYGIENICINDUSTRIAL ENCLOSURES  
IP66, IP67, IP68 AND IP69K

Buy direct from manufacturer of custom made IP66, IP67, IP68 and IP69K heavy duty industrial and waterproof electrical enclosures AISI 304L and 316L made by standard IEC 60529. Delvalle has tested all sizes and dimensions of waterproof enclosures according to EN 60529:2018. All weather resistant enclosures are more than simply rainproof, they meet a minimum of Nema 4X and IP66, IP67, IP68 and IP69k requirements to ensure your electronics are protected. From Junction boxes to industrial enclosures, Delvalle weatherproof enclosures offer a wide range of sizes and styles to keep your project waterproof.

CLIMATE CONTROL  
COOLING FOR ENCLOSURESCABLE GLANDS FOR  
ELECTRICAL ENCLOSURES



Paso del Prao, 6. 01320 Oyón (Álava). Spain  
P. +34 945 601 381  
comercial@delvalle.es | [www.delvallebox.com](http://www.delvallebox.com)  
**Contact us, we will be available at any time**

